

VA Master FGM1190 Glass Tube Variable Area Flowmeters

Robust and reliable glass tube variable area flowmeter

Measurement made easy

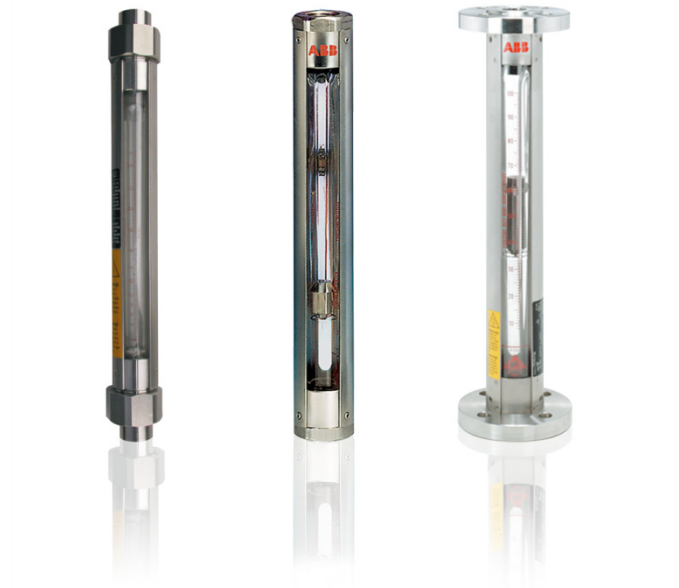

Function

- The glass tube variable area flowmeter can be used to measure the flow of liquids and gases

Areas of application

- Suitable for flow measurements in many industrial sectors such as apparatus engineering, the food and beverage industry, water treatment systems and chemistry
- The combination of various materials that come into contact with the medium make it possible to also adjust it for aggressive media

Product highlights

- Precision tubes with guide surfaces, guide ribs or guide rods
- Standard stainless steel housing
- Easy disassembly of the meter tube due to the O-ring seal
- Meter tube and float can be replaced independently of each other

Important product features

- A magnetically actuated alarm signaling unit can be attached to the flowmeter from size 1/2" up
- Suitability for use confirmed by the DVGW research unit at the Engler-Bunte Institute
- Suitable for use in a vacuum
- Polycarbonate security protection tube
- Easier to install and uninstall the device due to union nut fitting

SEITA

Soluciones en Instrumentación,
Automatización y Control Industrial

www.seita.com.co



Power and productivity
for a better world™



VA Master FGM1190

Glass Tube Variable Area Flowmeters

Overview

FGM1190-87	FGM1190-97	FGM1190-98
 <p style="text-align: center;">G11479</p>	 <p style="text-align: center;">G11480</p>	 <p style="text-align: center;">G11481</p>
<p>With threaded pipe connection conforming to DIN 2950</p>	<p>With vertical internal thread connection or threaded connector as per DIN 11851, DIN 405 Part 1 for the food industry</p>	<p>With flange connection as per DIN or ASME</p>

In addition to the above-mentioned designs, the FGM1190-95 model with horizontal internal thread connection is available on request.

Functional description

The VA Master FGM1190 series flowmeters work according to the float principle.

The position of the float in the conical glass meter tube is proportional to the flow. It can be read on the scale fitted to the meter tube.

Four different types of scale can be used:

- Directly readable scale in flow units
- Percent scale
- DK/DS scale
- Millimeter scale

When using the DK/DS scale a flow rate table is available for the flowmeter. For other operating conditions, the user can create additional tables.

Flowmeters in sizes 1/2" to 2" are provided with a percentage scale in the standard design. The device has a factory plate indicating the flow rate for the display of 100 %.

The other scale values can be linearly converted. A special reading curve is therefore not required.

On request, conversion equations for flow calculation for other operating conditions will be made available.

Introduction and basics

Installation conditions

General

The following points are to be considered during installation:

- Prior to installation in the pipeline, remove the wooden stick serving as a transportation lock from the meter tube.
- The glass tube variable area flowmeter is installed vertically in piping. The measuring media must flow from bottom to top.
- Keep the device as far as possible from pipe vibrations and powerful magnetic fields.
- The piping should be the same size as the connection size of the flowmeter.
- Inlet and outlet sections are not required.
- Avoid pulsating flows and sudden pressure surges.
- Use slow opening valves.
- If the flowmeter is installed in a pipeline where decommissioning is impossible or inexpedient, a bypass line should be provided.
- For gaseous measurement media, the flowmeter should be installed as close as possible to the pipe constrictions. The nominal diameter of the piping at the outlet of the flowmeter should be measured as small as possible.
- Shut-off and throttle valves should preferably be attached to the outlet of the flowmeter.
- For liquid measurement media, the nominal diameter of the pipeline should be measured as large as possible (as far as economically viable).

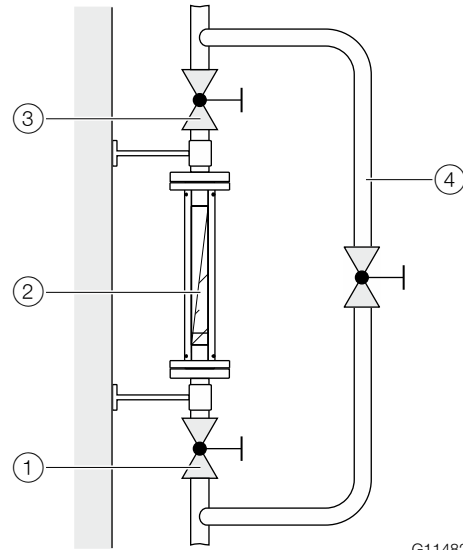

Fig. 1: Installation of the flowmeter

- ① Shut-off valve in the inlet ② Flowmeter
③ Shut-off valve in the outlet ④ Bypass line

Installation recommendations

Refer to VDI / VDE Directive 3513 sheet 3, Selection and Installation Recommendations for Variable Area Flowmeters.

Pressure chambers and collecting tanks

If piston pumps or compressors are used for the transport of the measuring media, a pulsating flow of the measurement media must be expected.

In order to reduce the pulsating of the float, the installation of pressure chambers or collecting tanks in the piping before the flowmeter is recommended.

VA Master FGM1190

Glass Tube Variable Area Flowmeters

Operating conditions

A variable area flowmeter is specified for a defined set of operating conditions of the measuring medium. For liquids and gases, these are pressure and temperature-related properties (density and viscosity) under operating conditions.

For gases, in particular, this means operating at a specific operating pressure and operating temperature. The specified accuracy of the device always refers to the operating conditions underlying the specification.

Pressure loss

The available operating pressure at the measuring point must be higher than the pressure loss listed for the flowmeter in the specifications.

It is important to also consider the pressure loss downstream from the flowmeter due to losses in the piping and other fittings.

For the design of the device please check the ABB Product Selection Assistant, available at www.abb.com/flow.

Prevention of compression oscillations when measuring gases

With low flow amounts and low operating pressure, so-called compression oscillations of the float can occur.

To prevent self-generated compression oscillations, note the following information from VDI / VDE 3513 Sheet 3:

- Select a flowmeter with the lowest possible pressure loss.
- Minimize the piping length between the flowmeter and the closest up or downstream throttling location.
- Restrict the usual measuring range from the usual 10 ... 100 % to 25 ... 100 %.
- When setting the flow rate value, always start assuming larger values.
- Increase the operating pressure and consider its effect on the flow rate values due to the change in gas density at the new operating conditions.
- Minimize non-throttled, free volumes upstream and downstream of the device.

Pressure shocks

Especially when measuring gases, it is possible that pressure or shock waves can occur when fast opening solenoid valves are employed and the piping cross-sections are not throttled, or if there are gas bubbles in liquids.

As a result of the sudden expansion of the gas in the piping, the float is forcibly driven against the upper floatstop. Under certain conditions, this can lead to destruction of the device.

Avoid pressure shocks when operating the devices.

Solids content in the measuring medium

Variable area flowmeters have only limited suitability for measuring media containing solids.

Depending on the concentration, particle size and type of solid, increased mechanical abrasion may occur, especially at the critical measuring edge of the float.

In addition, solidified deposits on the float can change its weight and shape.

These effects can lead to erroneous measurement results, depending on the float type.

In general, the use of appropriate filters is recommended in such applications.

For the flow measurement of measuring media containing magnetic particles, we recommend the installation of a magnetic separator upstream of the variable area flowmeter.

Float designs

With a range of around 100,000 possible variable area flowmeter designs, different meter tube float-scale combinations are used.

Float with guide ring

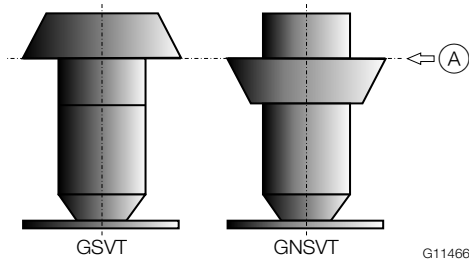

Fig. 2: Float with guide ring

(A) Index markers

In combination with three-rib meter tubes and a percentage scale, floats with a guide ring represent the standard design. GSVT type floats are essentially independent of viscosity and available in different materials and weights in the individual device sizes. The reverse head shape of GNSVT type makes it possible to achieve a 25 ... 30 % higher flow rate. This float shape is not suited for measuring media with higher viscosities. The VIN numbers in the float selection program must be observed.

The float is guided to the measuring edge and the guide ring in the guide ribs of the meter tube.

Ball float

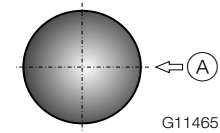

Fig. 3: Ball float

(A) Index markers

Ball floats are used to measure small flow rates for meter tube sizes 1/16 ... 1/4". To achieve as many measuring range levels as possible within a meter tube, ball floats made from various materials of different densities are available.

Float with low pressure loss

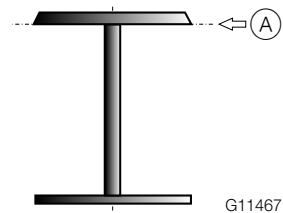

Fig. 4: Float with low pressure loss

(A) Index markers

Floats with low pressure loss are specially developed for the measurement of gaseous measuring media at low pressures and ensure an extremely low device pressure loss. They are used in conjunction with three-rib meter tubes.

VA Master FGM1190

Glass Tube Variable Area Flowmeters

Guided floats

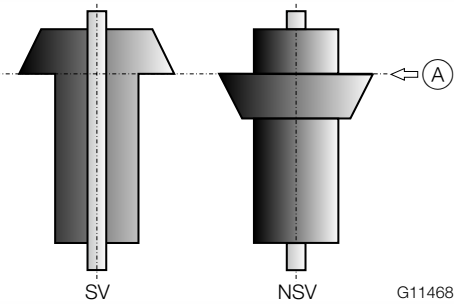

Fig. 5: Guided float

(A) Index markers

Guided floats are used in conjunction with smooth conical meter tubes. The float is guided on a rod that is firmly fitted in the meter tube.

Guided floats are used when the flow rate changes frequently and significantly (e.g. in the case of switching operations).

BL type float

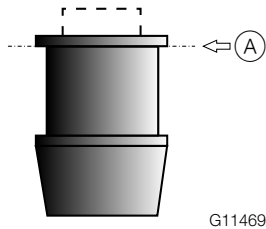

Fig. 6: BL type float

(A) Index markers

BL type floats are specially developed for measuring high flow rates with small meter tube sizes.

The float is guided in the guide ribs of the meter tube.

Scale designs

DK/DS scale

The DK/DS scale represents the diameter ratio of the meter tube as a numeric value. It can be used for gases and liquids in connection with the three-surface meter tube, and is especially well suited for varying operating data.

It comes supplied with a flow rate table to determine the flow rate displayed.

Percentage scale

The linearized percentage scale is the standard scale for all other variable area flowmeters, mostly for three-rib meter tubes and smooth conical meter tubes.

It shows the percentage based on the maximum flow rate and extends mostly over a total range of 8 to 100 %.

When the operating data, the physical properties of the measuring medium, as well as the float design are known, the maximum flow rates are relatively easy to calculate and convert. Each percentage scale has the accuracy specified by ABB.

Directly readable scale in flow units

The scale directly displays the volume or mass flow rate per unit of time: (e. g. l/h hydrogen, cm³/min H₂O). The scale is only valid for one measuring medium under precisely defined conditions. Certain limits to the universal applicability of the meter tubes are set by the directly readable scale.

Millimeter scale

The scale is generally only used if a specified flow value must be reproduced and the actual measuring range plays a minor role. In conjunction with viscous measuring media, this scale can be regarded as universal.

Meter tube designs

The meter tube is available with three designs.

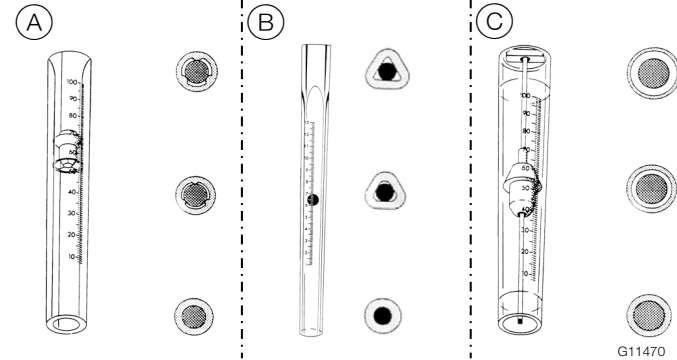

Fig. 7: Transmitter

- (A) Three-rib meter tube (B) Three-surface meter tube
(C) Smooth conical meter tube

Three-rib meter tube

The three-rib meter tube is used as standard for meter tube sizes from 1/2 ... 2". In this type of meter tube, the ribs parallel to the unit center lead the float over the entire measuring range.

The small distance between the float and the meter tube ensures identification of the index marker without any problems, even in murky measuring media. The three-rib meter tube is used together with floats with a guide ring.

Three-surface meter tube

The three-surface meter tube is used with smaller meter tube sizes from 1/16... 1/4". Three surfaces run parallel to the center axis in the meter tube that is extended conically in the flow direction. This surface guides the ball-float over the entire measuring range.

The small distance between the float and the meter tube ensures identification of the index marker without any problems, even in murky measuring media. The float is guided precisely in the middle of the meter tube.

Smooth conical meter tube

The smooth conical meter tube is usually only used for extreme operating conditions (e.g. frequent load changes and switching operations).

With a nominal diameter of 1 1/2 ... 2", upper range values are produced due to the larger cross-section compared with the three rib meter tube. In a meter tube, the float is guided on a guide rod.

Specifications

Scale design

Scale type	Meter tube size
DK/DS scale	1/16 ... 1/4" (directly readable on request)
Percentage scale	1/2 ... 2" (directly readable or in mm graduations on request)

Scale length	Meter tube size
100 mm	1/16"
130 mm	1/8 ... 1/4"
250 mm	1/2 ... 2"

Accuracy class

In accordance with VDI/VDE 3513, sheet 2

Accuracy class	Meter tube size
1,6 % qg = 50 %	1/8" ... 2"
6 % qg = 50 %	1/16", 1/2 ... 2" (with BL float type)

The specified accuracy class of the devices is only achieved by observing the valid operating conditions for the device (operating pressure and operating temperature).

VA Master FGM1190

Glass Tube Variable Area Flowmeters

Temperature limits °C (°F)

Ambient temperature T_{amb} .

Permissible ambient temperature range:

- Liquid measuring media: -40 ... 60 °C (-40 ... 140 °F)
- Gas measuring media: -40 ... 40 °C (-40 ... 104 °F)

Measuring medium temperature T_{medium}

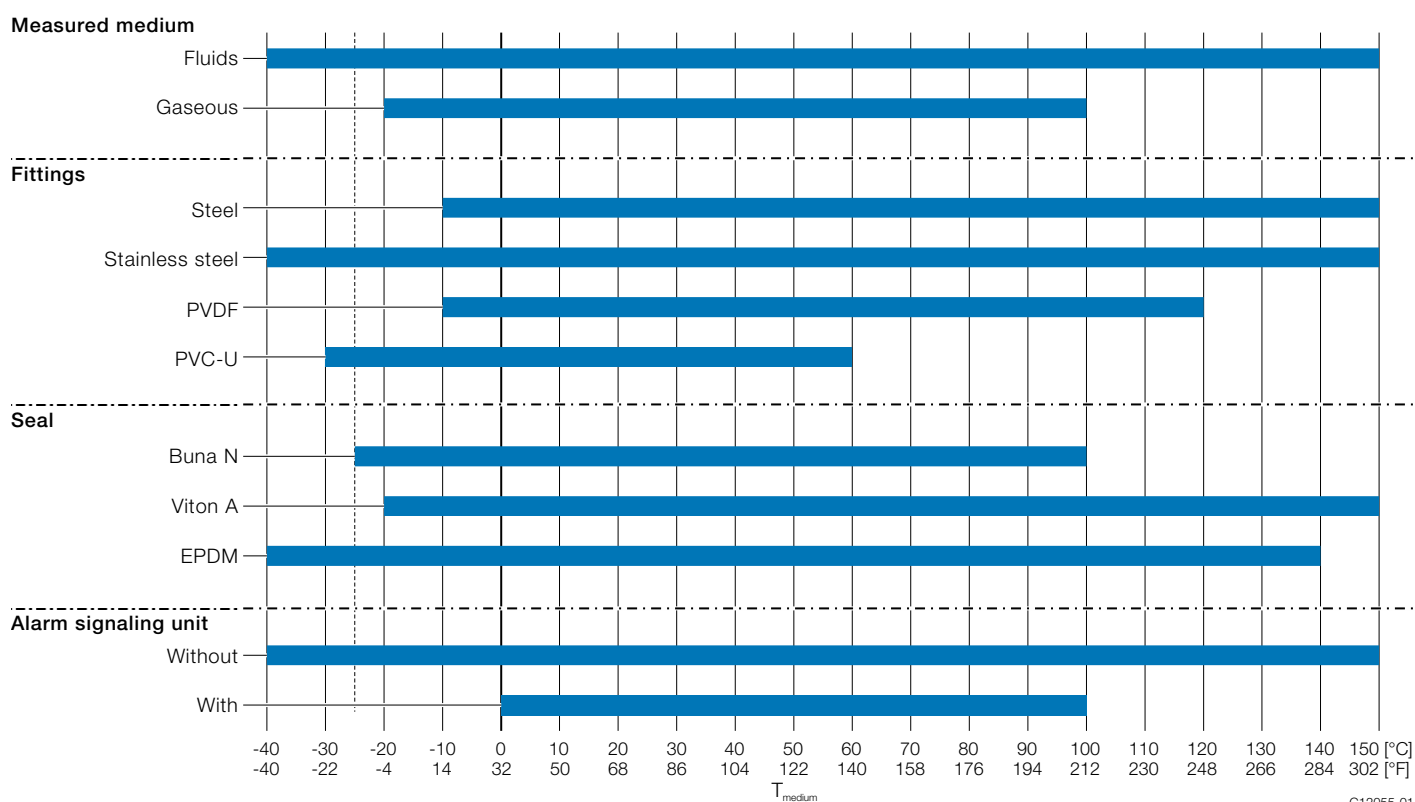

Fig. 8: Measured medium temperature permitted depending on the measured medium and equipment

For more information about the maximum measuring medium temperature, see chapter "Material load" on page 10.

Process connections

See chapter "Dimensions".

"Dimensions" on page 13

Weight

See chapter "Dimensions" on page 13.

Operating pressure

Maximum permissible operating pressure		
Meter tube size	Fluids	Gases
1/16", 1/8", 1/4"	30 bar (3 MPa / 435.1 psi)	30 bar (3 MPa / 435.1 psi)
1/2"	21 bar (2.1 MPa / 304.6 psi)	17 bar (1.7 MPa / 246.5 psi)
3/4"	17 bar (1.7 MPa / 246.5 psi)	13 bar (1.3 MPa / 188.6 psi)
1"	14 bar (1.4 MPa / 203 psi)	10 bar (1 MPa / 145 psi)
1 1/2"	9 bar (0.9 MPa / 130.5 psi)	4 bar (0.4 MPa / 58 psi)
2"	7 bar (0.7 MPa / 101.5 psi)	2 bar (0.2 MPa / 29 psi)

With meter tube sizes 1" ... 2", the maximum permissible operating pressure decreases by 1 % per 2 °C (3.6 °F) at operating temperatures above 95 °C (203 °F) (for liquids). The reduced pressures for gas applications result from safety considerations.

The strength of the polycarbonate protective tube reduces at increasing temperatures. Therefore, the following must be heeded for gas measurements:

- The specified maximum permissible operating pressure applies up to a measuring media temperature of 30 °C (86 °F) and ambient temperature of 30 °C (86 °F).
- With measuring medium or ambient temperatures above 30 °C (86 °F), the maximum permissible operating pressure decreases by 1.05 % per 1 °C (1.8 °F) (for gases).

Materials

Materials for wetted parts

Component/meter tube size	Material Standard	Option
Meter tube	Borosilicate glass	-
Float 1/16", 1/8"	Glass, SST 1.4401 (AISI 316), sapphire	Carboloy, tantalum
1/4"	Glass, SST 1.4401 (AISI 316)	Carboloy, tantalum, sapphire
1/2 ... 2"	SST 1.4571 (AISI 316 Ti)	SST 1.4571 (AISI 316 Ti), PVC
Floatstop (inlet) 1/16", 1/8", 1/4"	SST 1.4310 (AISI 301)	-
1/2 ... 2"	SST 1.4571 (AISI 316 Ti)	Hastelloy B, CrNi steel 1.4310 (AISI 301)
Floatstop (outlet) 1/16 ... 1/4"	SST 1.4310 (AISI 301)	SST 1.4571 (AISI 316 Ti)
1/2 ... 2"	SST 1.4310 (AISI 301)	-
Fitting	SST 1.4571 (AISI 316 Ti)	Steel, PVC, PVDF
O-rings	Buna N	Viton A, ethylene-propylene, silicone

Materials for other components

Component	Material
Housing	SST 1.4310 (AISI 301)
Flange	SST 1.4310 (AISI 301)

VA Master FGM1190

Glass Tube Variable Area Flowmeters

Material load

Metal fitting with internal thread

Metal fitting with thread DIN 11851

Types FGM1190-87, -95, -97

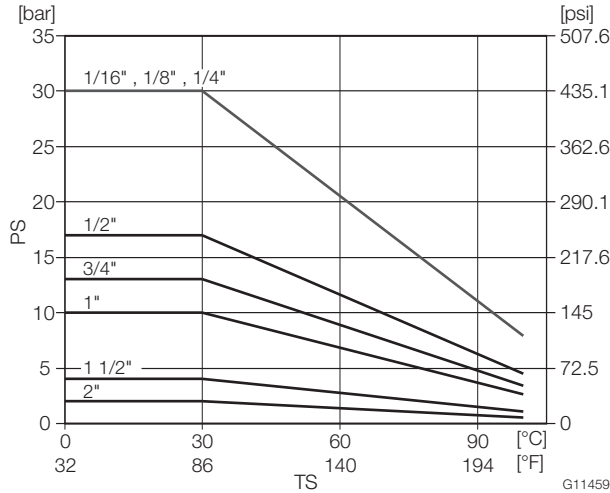

Fig. 9: Material load graph for gas

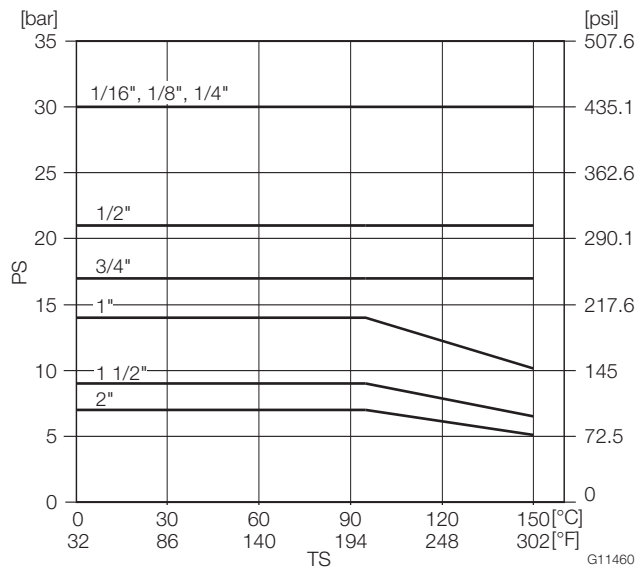

Fig. 10: Material load graph for liquids

Plastic fitting

Types FGM1190-95, -97, -98

Plastic fitting with flange PN 40, PN 16, Class 150, 300

Metal fitting with flange PN 40, PN 16, Class 300

Type FGM1190-98

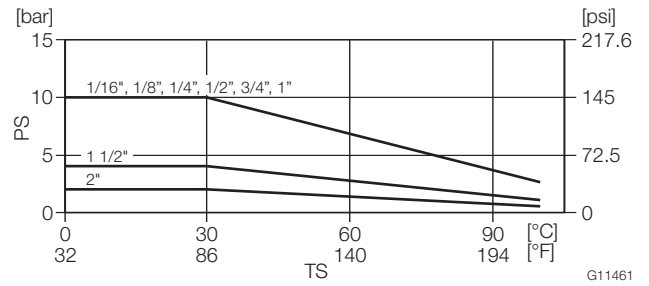

Fig. 11: Material load graph for gas

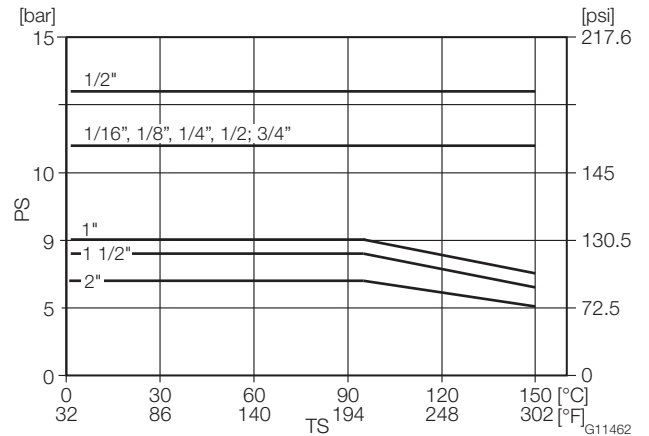

Fig. 12: Material load graph for liquids

Metal fitting with flange PN 40, PN 16, CL 300

Type FGM1 190-98

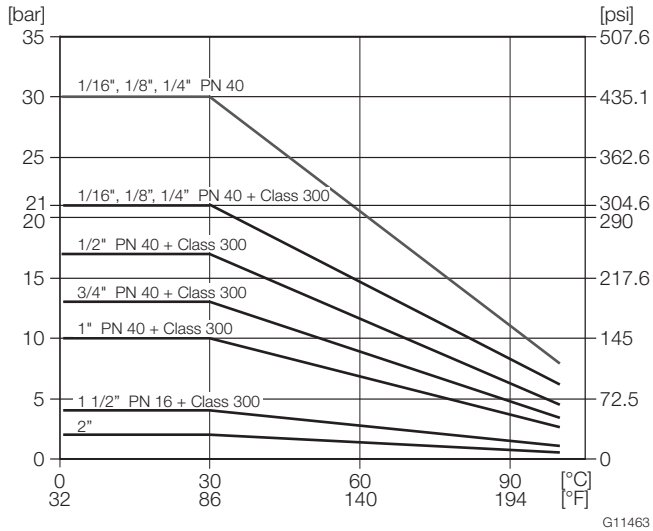

Fig. 13: Material load graph for gas

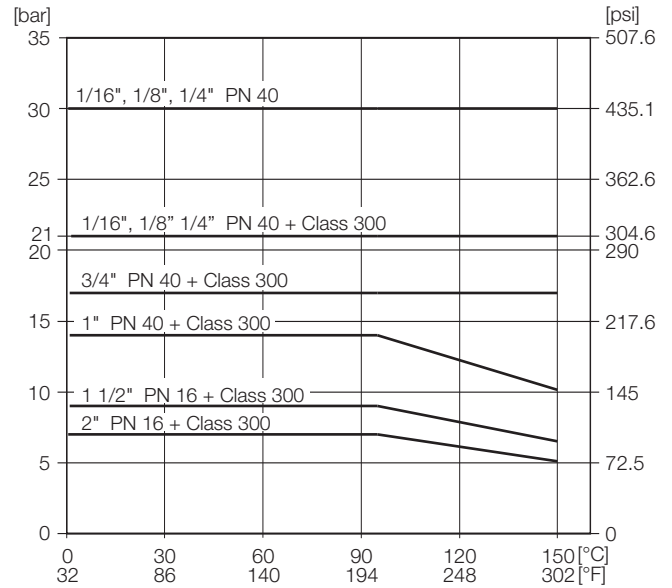

Fig. 14: Material load graph for liquids

Measuring range table

The data listed applies to water at 20 °C (68 °F), 1 kg/dm³ (62.43 lb/ft³), 1 mPas (1 cP) and to air at 0 °C (32 °F), 1013 mbar (14.7 psia).

To set up devices for different measurement media or operating conditions please check the ABB Product Selection Assistant, available at www.abb.com/flow.

Process connection	Meter tube size	Minimum measuring range		Maximum measuring range	
		Water	Air	Water	Air
1/4"	1/16"	0.003 ... 0.03 l/h	0.00029 ... 0.0029 m ³ /h	0.1 ... 1.12 l/h	0.004 ... 0.04 m ³ /h
1/4"	1/8"	0.037 ... 0.37 l/h	0.0022 ... 0.022 m ³ /h	1 ... 10 l/h	0.033 ... 0.33 m ³ /h
1/4"	1/4"	0.47 ... 4.7 l/h	0.0223 ... 0.223 m ³ /h	13 ... 132 l/h	0.4 ... 4.03 m ³ /h
1/2"	1/2"	4 ... 43 l/h	0.13 ... 1.3 m ³ /h	45 ... 419 l/h	1.8 ... 12.3 m ³ /h
3/4"	3/4"	14 ... 144 l/h	0.4 ... 4.3 m ³ /h	130 ... 1300 l/h	3.8 ... 38.7 m ³ /h
1"	1"	30 ... 310 l/h	0.9 ... 9.2 m ³ /h	420 ... 2800 l/h	12 ... 83 m ³ /h
1 1/2"	1 1/2"	50 ... 560 l/h	1.7 ... 17.3 m ³ /h	400 ... 4800 l/h	12 ... 142.5 m ³ /h
2"	2"	140 ... 1420 l/h	4 ... 42.6 m ³ /h	1800 ... 9650 l/h	54 ... 285 m ³ /h
2"	2" P1)	800 ... 9000 l/h	20 ... 270 m ³ /h	3400 ... 17,000 l/h	100 ... 510 m ³ /h

1) Design with guide rods

VA Master FGM1190

Glass Tube Variable Area Flowmeters

Alarm signaling unit

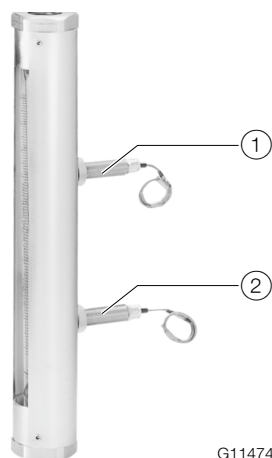

G11474

Fig. 15: Alarm signaling unit 55AX1000

① Max. alarm signaling unit ② Min. alarm signaling unit

One or two 55AX1000 type alarm signaling units can optionally be attached to the flowmeter housing.

The alarm signaling unit is designed as a potential-free contact, actuated by a magnet in the float.

An external one or two-channel switching amplifier is required to operate the alarm signaling unit.

NOTE

- The alarm signaling unit is suitable only in connection with flowmeters of Type FGM1190 with a meter tube size > 1/4".
- The alarm signaling unit is suitable only in connection with float types G(N)SVT, (N)SVP and BL.

The alarm signaling unit is used in a guide slot in the flowmeter housing and can be adjusted across the entire measuring range.

Specifications	
Operating mode	Inert gas switch (reed contact, bistable switching behavior)
Switching behavior	
— Lower limit value	Contact closes in the event of a falling float
— Upper limit value	Contact closes in the event of a rising float
Switching capacity	Maximum 10 VA, $U_B = 30$ V, 50 / 60 Hz
Permissible ambient temperature	-20 ... 60 °C (-4 ... 140 °F)
Connection type	Silicone cable SIHF-I 2 x 0.5 mm ² , length 1.75 m (5.74 ft)
IP rating	IP 65 (in accordance with DIN EN 60529)
Material	
— Alarm signaling unit	Brass, nickel-plated
— Housing	Polyamide
Weight	Approx. 0.7 kg (1.54 lb)

Switching amplifier

Model KF_SR2-Ex1W: 1-channel

Model KF_SR2-Ex2W: 2-channel

Specifications	
Power supply	230 V AC, +10 % / -15 %, 45 ... 60 Hz 115 V AC, +10 % / -15 %, 45 ... 60 Hz 24 V DC, +10 % / -15 %
Output	One or two switching relays with potential-free changeover contacts
Switching capacity	Maximum 250 V, maximum 4 A, maximum 500 VA
Maximum permissible cable length	Between switch amplifier and alarm signaling unit: 300 m (984 ft)
Permissible ambient temperature range	-20 ... 60 °C (-4 ... 140 °F)
Electrical connection	Screw terminals, maximum 2.5 mm ² (14 AWG)
Type of assembly	35 mm top-hat rail in accordance with EN 60715:2001
IP rating	IP 20 in accordance with EN 60529
Weight	Approx. 150 g (0.3 lb)

NOTE

See the switching amplifier data sheets for information on Ex-marking and the Ex relevant specifications for the switching amplifiers.

Dimensions

Model FGM1190-97

Screw connection with female thread in accordance with DIN ISO 228.

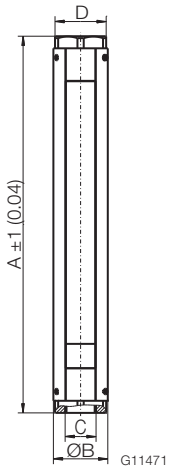

Measuring tube sizes	A mm (inch)	Diameter B mm (inch)	C	D Width across flats mm	Approx. weight kg (lb)
1/16 ... 1/4"	260 (10.24)	29 (1.14)	G 1/4"	27	0.5 (1.1)
1/2"	405 (15.94)	40 (1.57)	G 1/2"	36	1.7 (3.8)
3/4"	405 (15.94)	53 (2.09)	G 3/4"	50	2.3 (5.0)
1"	405 (15.94)	58.5 (2.30)	G 1"	55	2.7 (6.0)
1 1/2"	420 (16.54)	78 (3.07)	G 1 1/2"	65	4.4 (9.7)
2"	420 (16.54)	97 (3.82)	G 2"	85	6.5 (14.3)

Threaded spud in accordance with DIN 11851, DIN 405 part 1

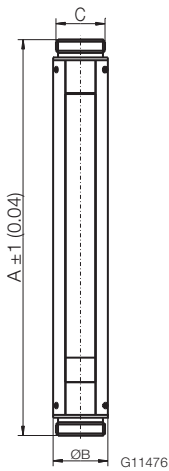

Measuring tube sizes	A mm (inch)	Diameter B mm (inch)	C	Threaded connector	Approx. weight kg (lb)
1/2"	423 (16.65)	40 (1.57)	Rd 34x1/8"	SC 15	1.7 (3.8)
3/4"	423 (16.65)	53 (2.09)	Rd 44x1/6"	SC 20	2.3 (5.0)
1"	423 (16.65)	58.5 (2.30)	Rd 52x1/6"	SC 25	2.7 (6.0)
1 1/2"	441 (17.36)	78 (3.07)	Rd 65x1/6"	SC 40	4.4 (9.7)
2"	437 (17.20)	97 (3.82)	Rd 78x1/6"	SC 50	6.5 (14.3)

VA Master FGM1190

Glass Tube Variable Area Flowmeters

Model FGM1190-98

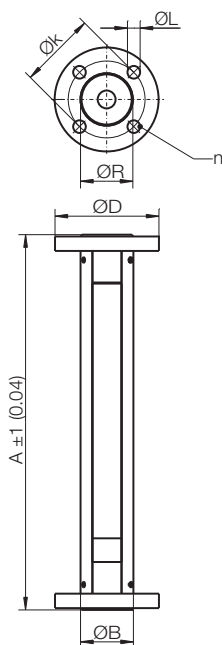

G11477

Measuring tube sizes	Flange in accordance with DIN 2501									Weight
	DN	PN	A mm (inch)	Diameter B mm (inch)	Diameter D mm (inch)	Diameter k mm (inch)	Diameter R mm (inch)	Diameter L mm (inch)	n	approx. kg (lb)
1/16 ... 1/4"	10	40	270 (10.63)	29 (1.14)	90 (3.45)	60 (2.36)	32 (1.26)	14 (0.55)	4	1.4 (3.1)
1/2"	15	40	415 (16.34)	40 (1.57)	95 (3.74)	65 (2.59)	39 (1.54)	14 (0.55)	4	2.4 (5.3)
3/4"	20	40	415 (16.34)	53 (2.09)	105 (4.13)	75 (2.95)	49 (1.93)	14 (0.55)	4	3.5 (7.7)
1"	25	40	415 (16.34)	58.5 (2.30)	115 (4.53)	85 (3.35)	58 (2.28)	14 (0.55)	4	4.7 (10.4)
1 1/2"	40	16	425 (16.73)	78 (3.07)	150 (5.91)	110 (4.33)	74 (2.91)	18 (0.71)	4	7.5 (16.5)
2"	50	16	425 (16.73)	97 (3.82)	165 (6.50)	125 (4.92)	94 (3.70)	18 (0.71)	4	10.0 (22.0)

Measuring tube sizes	Flange in accordance with ASME CL 150 ¹⁾									Weight
	DN	A mm (inch)	Diameter B mm (inch)	Diameter D mm (inch)	Diameter k mm (inch)	Diameter R mm (inch)	Diameter L mm (inch)	n	approx. kg (lb)	
1/16 ... 1/4"	1/2"	270 (10.63)	29 (1.14)	88.9 (3.50)	60.5 (2.38)	32.0 (1.26)	15.9 (0.63)	4	1.4 (3.1)	
1/2"	1/2"	415 (16.34)	40 (1.57)	88.9 (3.50)	60.5 (2.38)	38.8 (1.53)	15.9 (0.63)	4	2.4 (5.3)	
3/4"	3/4"	415 (16.34)	53 (2.09)	98.4 (3.87)	69.8 (2.75)	48.8 (1.92)	15.9 (0.63)	4	3.5 (7.7)	
1"	1"	415 (16.34)	58.5 (2.30)	108 (4.25)	79.4 (3.12)	57.8 (2.28)	15.9 (0.63)	4	4.7 (10.4)	
1 1/2"	1 1/2"	425 (16.73)	78 (3.07)	127 (5.00)	98.4 (3.87)	73.8 (2.91)	15.9 (0.63)	4	7.5 (16.5)	
2"	2"	425 (16.73)	97 (3.82)	152 (5.98)	121 (4.76)	93.8 (3.69)	19.0 (0.75)	4	10.0 (22.0)	

Measuring tube sizes	Flange acc. to ASME CL 300									Weight
	DN	A mm (inch)	Diameter B mm (inch)	Diameter D mm (inch)	Diameter k mm (inch)	Diameter R mm (inch)	Diameter L mm (inch)	n	approx. kg (lb)	
1/16 ... 1/4"	1/2"	270 (10.63)	29 (1.14)	95.2 (3.75)	66.5 (2.62)	32.0 (1.26)	15.9 (0.63)	4	1.4 (3.1)	
1/2"	1/2"	415 (16.34)	40 (1.57)	95.2 (3.75)	66.5 (2.62)	38.8 (1.53)	15.9 (0.63)	4	2.4 (5.3)	
3/4"	3/4"	415 (16.34)	53 (2.09)	117.5 (4.63)	82.5 (3.25)	48.8 (1.92)	19.0 (0.75)	4	3.5 (7.7)	
1"	1"	415 (16.34)	58.5 (2.30)	123.8 (4.87)	88.9 (3.50)	57.8 (2.28)	19.0 (0.75)	4	4.7 (10.4)	
1 1/2"	1 1/2"	425 (16.73)	78 (3.07)	156.6 (6.17)	114.3 (4.50)	73.8 (2.91)	22.5 (0.87)	4	7.5 (16.5)	
2"	2"	425 (16.73)	97 (3.82)	165.1 (6.50)	127.0 (5.00)	93.8 (3.69)	19.0 (0.75)	8	10.0 (22.0)	

1) Problems can arise when using 1/2" screw heads due to the ratio of bolt hole and housing diameter. If necessary the side of the screw head turned to the housing should be levelled off.

Model FGM1190-87

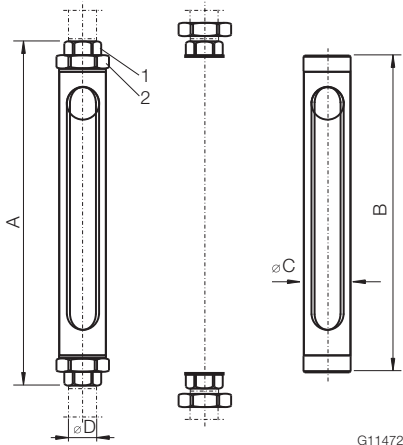

G11472

Measuring tube sizes	A mm (inch)	B mm (inch)	Ø C mm (inch)	Width across flats		Weight approx. kg (lb)
				1 mm	2 mm	
1/4"	270 (10.63)	234 (9.21)	29 (1.14)	18	32	0.6 (1.3)
1/2"	415 (16.34)	366 (14.41)	40 (1.57)	26	46	1.4 (3.1)
3/4"	415 (16.34)	366 (14.41)	53 (2.09)	31	55	2.2 (4.9)
1"	420 (16.54)	366 (14.41)	58.5 (2.30)	38	65	2.9 (6.4)
1 1/2"	455 (17.91)	386 (15.20)	78 (3.07)	54	85	4.7 (10.4)
2"	460 (18.11)	386 (15.20)	97 (3.82)	67	105	6.8 (15)

Model FGM1190-95

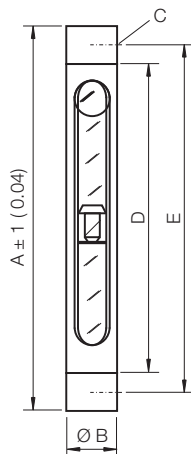

G11473

Measuring tube sizes	A mm (inch)	Diameter B mm (inch)	C mm (inch)	D mm (inch)	E mm (inch)	Weight
						approx. kg (lb)
1/2"	470	40 (1.57)	G 1/2"	383	430	1.4 (3.1)
3/4"	490	53 (2.09)	G 3/4"	379	440	2.2 (4.9)
1"	490	58.5 (2.30)	G 1"	376	440	2.9 (6.4)

VA Master FGM1190

Glass Tube Variable Area Flowmeters

Accessories

Needle valves

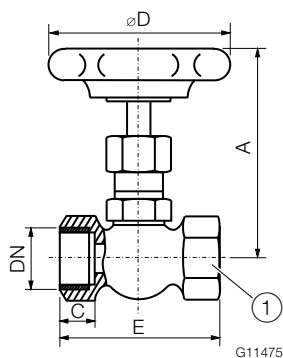

Fig. 16: Brass needle valve

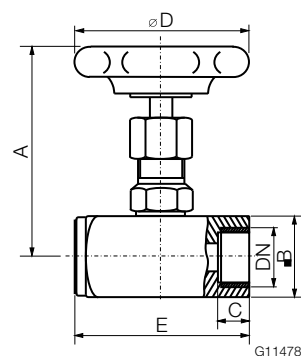

Fig. 17: Stainless steel needle valve

Needle valves for installation in the piping before or after the flowmeter. Valves in the in-line housing with female thread connections. For ordering information, see chapter "Ordering information needle valves" on page 27.

Drawing	Material	Pressure rating	Temperature
Fig. 16	Brass	PN 100	maximum 100 °C (212 °F)
Fig. 17	Stainless steel 1.4571 (AISI 316Ti)	PN 200	maximum 180 °C (356 °F)

Brass needle valve Fig. 16

DN	Ø D mm (inch)	A mm (inch)	C mm (inch)	E mm (inch)	Width across flats mm
G 1/4"	50 (1.97)	72 (2.83)	10 (0.39)	50 (1.97)	22
G 1/2"	63 (2.48)	72 (2.83)	12 (0.47)	55 (2.17)	25
G 3/4"	63 (2.48)	95 (3.74)	14 (0.55)	67 (2.64)	32
G 1"	90 (3.54)	130 (5.12)	17 (0.67)	74.5 (2.93)	40

Stainless steel needle valve Fig. 17

DN	Ø D mm (inch)	A mm (inch)	B mm (inch)	C mm (inch)	E mm (inch)
G 1/4"	50 (1.97)	72 (2.83)	25 (0.98)	13 (0.51)	50 (1.97)
G 1/2"	63 (2.48)	72 (2.83)	30 (1.18)	16 (0.63)	60 (2.36)
G 3/4"	63 (2.48)	95 (3.74)	35 (1.38)	18 (0.71)	75 (2.95)
G 1"	90 (3.54)	130 (5.12)	45 (1.77)	22 (0.87)	100 (3.94)
1/4" NPT	50 (1.97)	72 (2.83)	25 (0.98)	13 (0.51)	50 (1.97)
3/8" NPT	50 (1.97)	72 (2.83)	25 (0.98)	13 (0.51)	55 (2.17)
1/2" NPT	63 (2.48)	72 (2.83)	30 (1.18)	16 (0.63)	60 (2.36)

Ex-relevant specifications for operation in zones 2, 22

The glass tube variable area flowmeter can be used without further restrictions in the hazardous area of Zone 2 and Zone 22.

Flowmeter Ex-marking

II 3G Tx Gc
II 3DTx Dc

Surface temperature

Notice: The maximum surface temperature of the device corresponds to the maximum measuring medium temperature (if this is higher than the ambient temperature). If there are uncertainties regarding the maximum measuring medium temperature, the corresponding security surcharges for the maximum surface temperature when using the device are included in the calculations.

D55AX alarm signaling unit ex-marking

II 3G Ex nA IIC T6 Gc

The rated voltage of the alarm signaling unit is $U_M = 60 \text{ V}$.

Electrical connection for the alarm signaling unit

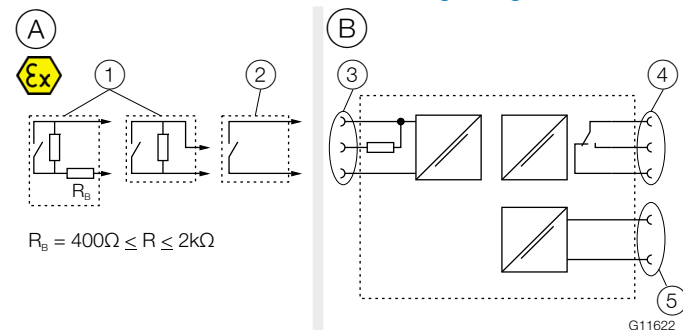

Fig. 18: Connection of alarm signaling unit to a switching amplifier (example)

- (A) Hazardous area (B) Non-hazardous area
 (1) Alarm signaling unit in NAMUR wiring
 (2) D55AX alarm signaling unit (3) Switching amplifier input
 (4) Switching amplifier output (5) Switching amplifier power supply

The circuits (between the alarm signaling units and the switching amplifier) are intrinsically safe. The switching amplifier itself must be mounted outside the hazardous area.

Information for safe operation in potentially explosive atmospheres

When operating in hazardous areas, observe the following points and instructions.

Assembly / Commissioning

When installing the flowmeter, ensure that there are no external mechanical influences on the flowmeter.

Operation

- Ensure that the chemical resistance and temperature resistance of the gaskets are observed.
- Ensure that the permissible operating conditions and ambient conditions are observed.
- Ensure that the measuring medium does not contain any corrosive metal particles.
- Ensure that liquid measuring media do not contain any gas inclusions.
- Avoid pulsating flow of the measuring media.
- Avoid compression oscillations, see chapter "Prevention of compression oscillations when measuring gases" on page 4.

Maintenance / Repair

Ensure that only original parts are used during maintenance and repair work.

- Ensure that there are no solid particles or loose parts in the piping.
- When cleaning the plastic protective pipe, only use moist cloths to avoid the risk of explosion due to electrostatic charging.

VA Master FGM1190

Glass Tube Variable Area Flowmeters

Ordering Information

Main ordering information FGM1190-87

Glass Tube Variable Area Flowmeter, with screw joint

Basic model	D10A11	XX	X	X	X	X	X	XX	X	X	X	X	X	X	X	X	X	XXX	XX	X
Connection	Continued on next page																			
Pipe union (1/4 ... 2 in.)	87																			
Design Level	(Specified by ABB)																			
	X																			
Instrument Design	Standard																			
	A																			
Alarm Unit	Without																			
	0																			
	Prepared for alarm																			
	1) 1																			
Fitting Material	AISI 316Ti SST (1.4571)																			
	T																			
Applications	Fluid																			
	1																			
	Gas																			
	2																			
	Oxygen																			
	3																			
Mounting / Protection Shield	Pipe mounting / With																			
	40																			
O-Ring Materials	Buna N																			
	N																			
	Viton A																			
	A																			
	Ethylene-Propylene																			
	F																			
Connection Type	Pipe connection																			
	3																			
Connection Size / Metering Tube Size	1/4 in. // 1/16 in.																			
	2) 7																			
	1/4 in. // 1/8 in.																			
	2) 8																			
	1/4 in. // 1/4 in.																			
	2) 1																			
	1/2 in. // 1/2 in.																			
	2																			
	3/4 in. // 3/4 in.																			
	3																			
	1 in. // 1 in.																			
	4																			
	1-1/2 in. // 1-1/2 in.																			
	5																			
	2 in. // 2 in.																			
	6																			
Floatstop Materials	(Specified by ABB)																			
	X																			
Accuracy	Standard																			
	A																			
	Calibration																			
	B																			
	Viscosity calculation +/- 4 % of max. flow																			
	3) C																			

Main ordering information FGM1190-87		X	X	XXX	XX	X
Name Plate						
German		D				
English		E				
Certificates						
Standard			A			
Inspection certificate 3.1 acc. EN 10204			B			
Pressure test acc. AD2000			C			
Material certificate 3.1 acc. EN 10204 with pressure test acc. AD2000			D			
Others			Z			
Tube / Float Combination						
(Specified by ABB)					XXX	
Float Material						
AISI 316Ti SST (1.4571)				3)	01	
PVC				3)	08	
Glass				4)	40	
Saphir				4)	41	
AISI 316L SST (1.4404)				4)	42	
Carboloy				4)	43	
Tantalum				4)	44	
Scale Design						
Direct reading scale						A
Percentage scale				3)		P
Millimeter scale						M
Scale DK/DS				4)		D

- 1) Alarm signalling unit D55AX, ordering information see chapter "Ordering information alarm signalling unit type D55AX" on page 26.
- 2) Not available with alarm signalling unit.
- 3) 1/2 ... 2 in.
- 4) 1/16 ... 1/4 in.

VA Master FGM1190

Glass Tube Variable Area Flowmeters

Main ordering information FGM1190-95

Glass Tube Variable Area Flowmeter, with horizontal screw connection

Basic model	D10A11	XX	X	X	X	X	X	XX	X	X	X	X	X	X	X	X	X	X	XXX	XX	X
Connection	Continued on next page																				
Horizontal screwed connection (1/2 ... 1 in.)	95																				
Design Level																					
(Specified by ABB)	X																				
Instrument Design																					
Standard	A																				
Alarm Unit																					
Without	(0																			
Prepared for alarm	1)	1																			
Fitting Material																					
AISI 316Ti SST (1.4571)	T																				
PVC	C																				
Applications																					
Fluid	1																				
Gas	2																				
Oxygen	3																				
Mounting / Protection Shield																					
Pipe mounting / With	40																				
Rear panel mounting / With	60																				
O-Ring Materials																					
Buna N	N																				
Viton A	A																				
Ethylene-Propylene	F																				
Connection Type																					
Cylindric pipe thread	1																				
NPT pipe thread	6																				
Connection Size / Metering Tube Size																					
1/2 in. / 1/2 in.	2																				
3/4 in. / 3/4 in.	3																				
1 in. / 1 in.	4																				
Floatstop Materials																					
(Specified by ABB)	X																				
Accuracy																					
Standard	A																				
Calibration	B																				
Viscosity calculation +/- 4 % of max. flow	C																				

Main ordering information FGM1190-95		X	X	XXX	XX	X
Name Plate						
German		D				
English		E				
Certificates						
Standard			A			
Inspection certificate 3.1 acc. EN 10204			B			
Pressure test acc. AD2000			C			
Material certificate 3.1 acc. EN 10204 with pressure test acc. AD2000			D			
Others			Z			
Tube / Float Combination						
(Specified by ABB)				XXX		
Float Material						
AISI 316Ti SST (1.4571)					01	
PVC					08	
Scale Design						
Direct reading scale						A
Percentage scale						P
Millimeter scale						M

1) Alarm signalling unit D55AX, ordering information see chapter "Ordering information alarm signalling unit type D55AX" on page 26.

VA Master FGM1190

Glass Tube Variable Area Flowmeters

Main ordering information FGM1190-97

Glass Tube Variable Area Flowmeter, with vertical screw connection

Basic model	D10A11	XX	X	X	X	X	X	XX	X	X	X	X	X	X	X	X	X	X	XXX	XX	X
Continued on next page																					
Connection																					
Vertical screwed connection (1/16 ... 2 in.)		97																			
Design Level																					
(Specified by ABB)		X																			
Instrument Design																					
Standard		A																			
Pole guide (1/2 ... 2 in.)		P																			
Alarm Unit																					
Without		1) 0																			
Prepared for alarm		1) 1																			
Fitting Material																					
AISI 316Ti SST (1.4571)		T																			
PVC		2) C																			
PVDF		F																			
Applications																					
Fluid		1																			
Gas		2																			
Oxygen		3																			
Mounting / Protection Shield																					
Pipe mounting / With		40																			
Rear panel mounting / With		60																			
O-Ring Materials																					
Buna N		N																			
Viton A		A																			
Ethylene-Propylene		F																			
Connection Type																					
Pipe thread		1																			
Thread DIN 11851		2) 2																			
Thread NPT		6																			
Connection Size / Metering Tube Size																					
1/4 in. / 1/16 in.		3) 7																			
1/4 in. / 1/8 in.		3) 8																			
1/4 in. / 1/4 in.		3) 1																			
1/2 in. / 1/2 in.		2																			
3/4 in. / 3/4 in.		3																			
1 in. / 1 in.		4																			
1-1/2 in. / 1-1/2 in.		5																			
2 in. / 2 in.		6																			

Main ordering information FGM1190-97	X	X	X	X	XXX	XX	X
Floatstop Materials							
(Specified by ABB)	X						
Accuracy							
Standard			A				
Calibration			B				
Viscosity calculation +/- 4 % of max. flow		2)	C				
Name Plate							
German				D			
English				E			
Certificates							
Standard					A		
Inspection certificate 3.1 acc. EN 10204					B		
Pressure test acc. AD2000					C		
Material certificate 3.1 acc. EN 10204 with pressure test acc. AD2000					D		
Others					Z		
Tube / Float Combination							
(Specified by ABB)						XXX	
Float Material							
AISI 316Ti SST (1.4571)					2)	01	
PVC					2)	08	
Glass					4)	40	
Saphir					4)	41	
AISI 316L SST (1.4404)					4)	42	
Carboloy					4)	43	
Tantalum					4)	44	
Scale Design							
Direct reading scale							A
Percentage scale					2)		P
Millimeter scale							M
Scale DK/DS					4)		D

1) Alarm signalling unit D55AX, ordering information see chapter "Ordering information alarm signalling unit type D55AX" on page 26.

2) 1/2 ... 2 in.

3) Not available with alarm signalling unit.

4) 1/16 ... 1/4 in.

VA Master FGM1190

Glass Tube Variable Area Flowmeters

Main ordering information FGM1190-98

Glass Tube Variable Area Flowmeter, with vertical flange connection

Basic model	D10A11	XX	X	X	X	X	X	XX	X	X	X	X	X	X	X	X	X	X	XXX	XX	X
Continued on next page																					
Connection																					
Vertical flanged connection (1/16 ... 2 in.)		98																			
Design Level																					
(Specified by ABB)		X																			
Instrument Design																					
Standard		A																			
Pole guide (1/2 ... 2 in.)		P																			
Alarm Unit																					
Without		1) 0																			
Prepared for alarm		1) 1																			
Fitting Material																					
AISI 316Ti SST (1.4571)		T																			
PVC (1/2 ... 2 in.)		C																			
PVDF (1/16 ... 2 in.)		F																			
Applications																					
Fluid		1																			
Gas		2																			
Oxygen		3																			
Mounting / Protection Shield																					
Pipe mounting / With		40																			
O-Ring Materials																					
Buna N		N																			
Viton A		A																			
Ethylene-Propylene		F																			
Connection Type																					
Flange DIN 2501		2) 4																			
Flange ASME CL 300		5																			
Flange ASME CL 150		7																			
Connection Size / Meter Tube Size																					
DN 10 (1/2 in.) / 1/16 in.		3) 7																			
DN 10 (1/2 in.) / 1/8 in.		3) 8																			
DN 10 (1/2 in.) / 1/4 in.		3) 1																			
DN 15 (1/2 in.) / 1/2 in.		2																			
DN 20 (3/4 in.) / 3/4 in.		3																			
DN 25 (1 in.) / 1 in.		4																			
DN 40 (1-1/2 in.) / 1-1/2 in.		5																			
DN 50 (2 in.) / 2 in.		6																			

Main ordering information FGM1190-98	X	X	X	X	XXX	XX	X
Floatstop Materials (Specified by ABB)	X						
Accuracy							
Standard			A				
Calibration			B				
Viscosity calculation +/- 4 % of max. flow	4)		C				
Name Plate							
German				D			
English				E			
Certificates							
Standard					A		
Inspection certificate 3.1 acc. EN 10204					B		
Pressure test acc. AD2000					C		
Material certificate 3.1 acc. EN 10204 with pressure test acc. AD2000					D		
Others					Z		
Tube / Float Combination (Specified by ABB)						XXX	
Float Material							
AISI 316Ti SST (1.4571)					4)	01	
PVC					4)	08	
Glass					5)	40	
Saphir					5)	41	
AISI 316L SST (1.4404)					5)	42	
Carboloy					5)	43	
Tantalum					5)	44	
Scale Design							
Direct reading scale							A
Percentage scale					4)		P
Millimeter scale							M
Scale DK/DS					5)		D

- 1) Alarm signalling unit D55AX, ordering information see chapter "Ordering information alarm signalling unit type D55AX" on page 26.
2) PN 40 (1-1/2 in. and 2 in. = PN 16)
3) Not available with alarm signalling unit.
4) 1/2 ... 2 in.
5) 1/16 ... 1/4 in.

Certificates

Description	Order number
FGM Works Certificate per EN 10204 2.1	BZ-11-0001-SDM
FGM Works Certificate per EN 10204 2.2	BZ-11-0002-SDM
FGM Color Penetration Test Report DIN 54152	BZ-11-0010-00-SDM
FGM Certificate of Compliance for Repaired Apparatus for Ex Atmospheres	BZ-13-1006-SDM
FGM Calibration Certificate plus Certificate of Compliance for Accuracy (not DN 100)	BZ-15-0016-SDM
FGM Certificate of Compliance for Accuracy	BZ-15-0018-02-SDM
FGM Certificate of Compliance of Visual and Dimensional Inspection	BZ-15-0040-SDM

VA Master FGM1190

Glass Tube Variable Area Flowmeters

Accessories

Main Ordering information alarm signalling unit type D55AX

Basic model	D55AX	X	X	X	X	X
Limit Alarm						
High limit value		1				
Low limit value		2				
High and low limit value		3				
Transistor Switch Amplifier						
Without			0			
With type KFA_-SR2-Ex1.W	(Note: 1)	1				
With type KFA_-SR2-Ex2.W	(Note: 2)	2				
Power Supply for Transistor Switch Amplifier						
Without				0		
115 V AC 50 / 60 Hz				1		
230 V AC 50 / 60 Hz				2		
24 V DC				3		
Design Level						
(Specified by ABB)						X
Suitable for						
Model 10A1187, 10A1190, 10B1190						A
Model 10A1187D, 10A1190D, 10B1190D						F

Note 1: For single alarm (high or low)

Note 2: For double alarm (high and low)

Ordering information switching amplifier

Description	Order number
Amplifier Model KFA5-SR2-Ex1.W, Single Alarm, 115 V 50 / 60 Hz	D163A011U01
Amplifier Model KFA6-SR2-Ex1.W, Single Alarm, 230 V 50 / 60 Hz	D163A011U02
Amplifier Model KFD2-SR2-Ex1.W, Single Alarm, 24 V DC	D163A011U03
Amplifier Model KFA5-SR2-Ex2.W, Double Alarm, 115 V 50 / 60 Hz	D163A011U04
Amplifier Model KFA6-SR2-Ex2.W, Double Alarm, 230 V 50 / 60 Hz	D163A011U05
Amplifier Model KFD2-SR2-Ex2.W, Double Alarm, 24 V DC	D163A011U06

Ordering information needle valves

Description	Order number
Needle Valve, Brass	
Needle Valve, Brass, 1/4 in., separate	1D125D1004
Needle Valve for oxygen applications, Brass, 1/4 in., separate	D125D001U01
Needle Valve, Brass, 1/2 in., separate	1D125D1005
Needle Valve for oxygen applications, Brass, 1/2 in., separate	D125D001U02
Needle Valve, Brass 3/4 in., separate	1D125D1006
Needle Valve for oxygen applications, Brass 3/4 in., separate	D125D001U03
Needle Valve, Brass 1 in., separate	1D125D1017
Needle Valve for oxygen applications, Brass 1 in., separate	D125D001U04
Needle Valve, stainless steel	
Needle Valve, AISI 316Ti SST (1.4571), 1/4 in., separate	1D125D1001
Needle Valve, AISI 316Ti SST (1.4571), 1/2 in., separate	1D125D1002
Needle Valve, AISI 316Ti SST (1.4571), 3/4 in., separate	1D125D1003
Needle Valve, AISI 316Ti SST (1.4571), 1 in., separate	1D125D1019
Needle Valve, AISI 316Ti SST (1.4571), 3/8 in. NPT, separate,	D125D003U01
Needle Valve, AISI 316Ti SST (1.4571), 1/4 in. NPT, separate	D125D003U02
Needle Valve, AISI 316Ti SST (1.4571), 1/2 in. NPT, separate	D125D003U03

Trademarks

® Buna-N is a registered trademark of DuPont Dow Elastomers.

™ Hastelloy B-3 is a Haynes International trademark

™ Viton is a DuPont de Nemours trademark

Contact us

ABB Limited

Process Automation

Howard Road, St. Neots
Cambridgeshire, PE19 8EU
UK

Tel: +44 (0) 870 600 6122

Fax: +44 (0)1480 213 339

Mail: enquiries.mp.uk@gb.abb.com

ABB Inc.

Process Automation

125 E. County Line Road
Warminster, PA 18974
USA

Tel: +1 215 674 6000

Fax: +1 215 674 7183

ABB Automation Products GmbH

Process Automation

Dransfelder Str. 2
37079 Goettingen
Germany

Tel: +49 551 905-0

Fax: +49 551 905-777

www.abb.com/flow

SEITA

Soluciones en Instrumentación,
Automatización y Control Industrial

www.seita.com.co

Note

We reserve the right to make technical changes or modify the contents of this document without prior notice. With regard to purchase orders, the agreed particulars shall prevail. ABB does not accept any responsibility whatsoever for potential errors or possible lack of information in this document.

We reserve all rights in this document and in the subject matter and illustrations contained therein. Any reproduction, disclosure to third parties or utilization of its contents - in whole or in parts - is forbidden without prior written consent of ABB.

Copyright© 2016 ABB

All rights reserved

D184S041U02 Rev. 07



Sales



Service