

ABB MEASUREMENT & ANALYTICS | DATA SHEET

ControlMaster CMF160

Universal process indicator, fieldmount



Measurement made easy

Making process indication easy

Cost saving field-mount design

- Wall-, pipe- or panel-mountable
- No need for an instrument panel
- IP66 and NEMA4X environmental protection

Comprehensive display of process status

- Crystal-clear, full-color TFT display
- User customizable
- Exceptionally easy to use

Frequency input

- Direct, high accuracy connection to electromagnetic flowmeters

Totalization and counter functions

- Calculation and display of flow total values
- Pulse counting capability

Problem-solving capability

- Flexible functionality including math, logic and totalization providing power to solve complex application requirements

Duty / Assist pump control

- Control of up to 6 pumps

Overview

The ControlMaster CMF160 is a feature-packed universal process indicator with a unique field-mountable design that enables wall-, or pipe-mounting without the need for an additional enclosure. A crystal-clear, full-color, TFT display shows operators exactly the information they need to know and provides operation and configuration menus in full text, making the CMF160 intuitive to use and very quick to install and commission.

Available as a basic indication-only model, or enhanced through plug-and-play function keys and I/O modules, the CMF160 offers totalization, level, math, logic, counter and alarm functions making it extremely flexible and able to solve many demanding application requirements.

MODBUS and Ethernet communication options ensure easy integration and connectivity to supervisory or control systems.

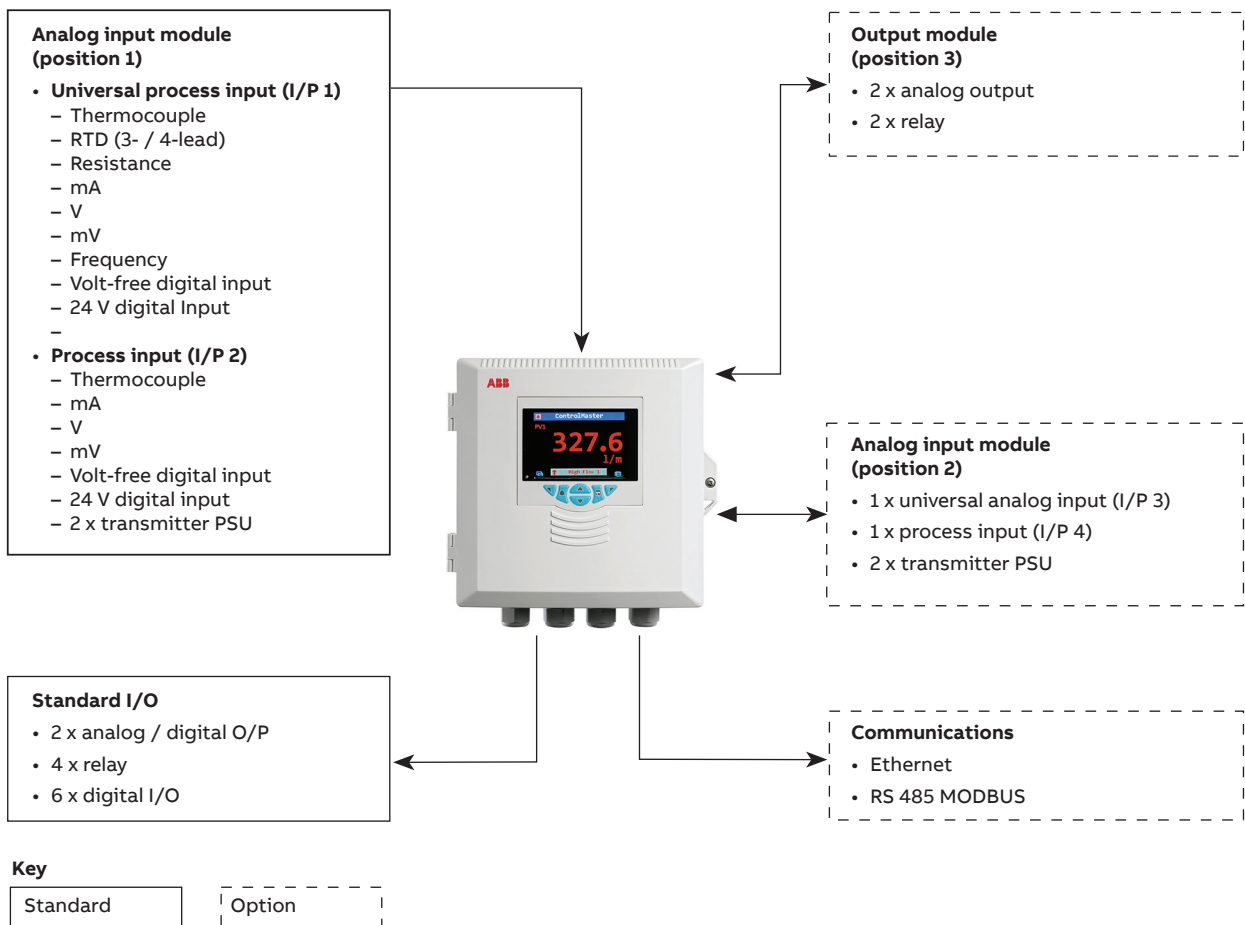

Highly scalable

The CMF160 is highly scalable in terms of both hardware and software, enabling it to meet the demands of simple indication duties through to more complex applications. The base CMF160 provides basic indication, totalization and level functionality. Templates and functionality can be increased by adding function keys to the basic model as shown in Figure 1, while retaining previous templates and functionality.

Level	Function keys	Template	Functionality
Base	0 	Single PV indication Single PV with totalizer Single totalizer Single level with volume	Process alarms Totalization Volume computation Specific gravity compensation Minimum, maximum and average calculation
Standard	1 		Logic Math Custom linearizers Delay timers Real time alarms Bank control Template customization
Dual	2 	Dual PV indication Dual PV with totalizer Dual totalizer Dual level with volume	Display customization

Figure 1 Overview of template options

Powerful operator display

The CMF160 features a full-color 5.5 cm (2.2 in.) display for displaying detailed process information to the user. Process details such as alarm messages and diagnostic information are displayed clearly in full text without the need for difficult-to-read scrolling displays.

Example of an operator page

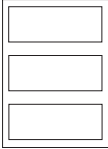
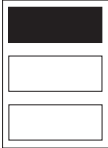
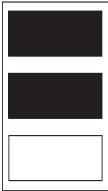
Automatic selection of standard display templates immediately makes best use of the CMF160's display. Extensive customization features then enable the displayed information to be tailored to suit the process requirements.



Figure 2 Single PV indication template display



Figure 3 Dual PV and totalization display

Diagnostics and alarm status display

The diagnostics and alarm status display provides detailed information on any active alarm or diagnostic condition. The operator can see, at-a-glance, the status of any alarm condition present within the process. In addition, diagnostic messages are presented clearly to the operator, enabling rapid notification and simple diagnosis of any critical instrument status condition.

Historical information of diagnostic messages can also be viewed in the indicator's diagnostic log.

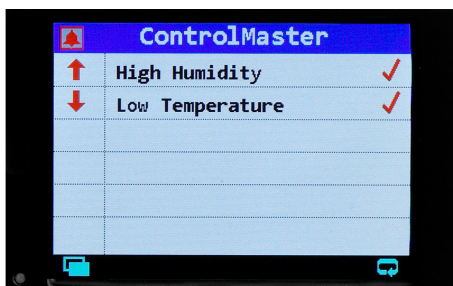

Figure 4 Alarm status display

Exceptionally easy to use

The CMF160's full text display and simple-to-navigate, pop-up menu makes operation exceptionally easy.

A programmable soft key enables commonly used functions, such as alarm acknowledgement and display selection, to be accessed easily by the operator.



Figure 5 Pop-up menu

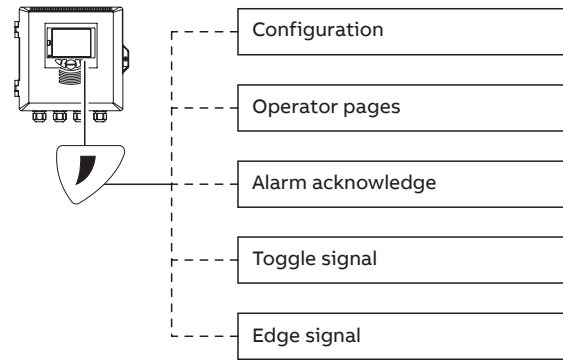

Figure 6 Programmable soft key

Problem solving flexibility

Extensive functionality is available to provide flexible problem-solving capability; making the CMF160 much more than just a process indicator.

Process alarms

8 independent process alarms can monitor any analog signal within the CMF160, enabling extensive process monitoring capability. Alarms can be used to drive physical outputs or soft-wired to other functions within the indicator.

Real-time alarms

The 'alarm clock' functionality provided by the CMF160's real-time alarms enables time-of-day decisions to be introduced into the indicator's actions or specific functions to be triggered routinely at specified times.

Delay timers

Event sequencing is enabled through the use of the CMF160's delay timers. A predetermined delay and output duration can be programmed into each delay timer and timers can be linked together.

Custom linearizers

The CMF160 has 2 independent 20-point custom linearizers that can be applied to any analog signal within the indicator. These linearizers can be used in applications such as level-to-volume conversion of a non-linear tank level or to accommodate special input signals or output devices.

Math

8 math blocks provide arithmetic, averaging, min. / max. hold, square root and signal switching functionality. Simple equations can be performed in a single math block or multiple math blocks can be nested together to construct complex equations.

Signal switching 'multiplexing' math blocks switch between 2 analog signals based on a trigger signal. For example, a backup sensor could be selected automatically on failure of a primary sensor.

Logic

8 comprehensive logic equations provide powerful interlock functionality. Inputs and outputs of the logic equations can be soft-wired to any digital signal within the indicator to maximize flexibility.

Totalizer

2 totalizers are available on the CMF160. The totalizers can be configured to perform multiple functions:

- integration against an analog signal to totalize flow
- counting digital pulses
- totalization of flow based on a frequency signal from an electromagnetic flow meter

Frequency input

For maximum accuracy the CMF160 can accept a frequency signal from an electromagnetic flow meter. The frequency signal can be totalized and displayed; an instantaneous flow rate can also be calculated and displayed on screen.

Communications

Extensive communication options enable the CMF160 to be integrated into larger control systems easily or connected to other process instrumentation.

RS 485 MODBUS

Using RS 485 MODBUS, values and status can be communicated to and from the indicator in real-time via an RS 485 connection.

Ethernet

Optional Ethernet communications enable ControlMaster to be integrated in to an Ethernet network quickly. The following functionality is provided:

- Email
 - Notification of a critical process event or status can be made by email. Multiple events can trigger an email that can be sent to multiple recipients
- Webserver
 - The CMF's integrated webserver enables the current status of the process and indicator to be viewed remotely using a standard web browser

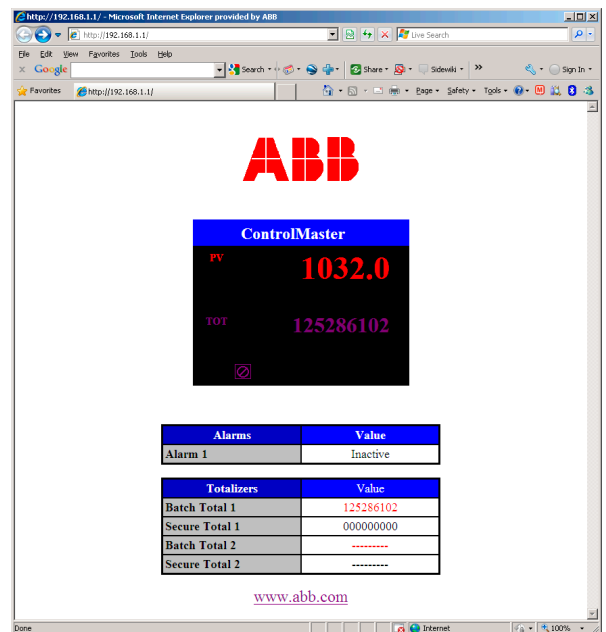

Figure 7 Webserver

- MODBUS TCP
 - Process values and status can be communicated to and from the CMF160 in real-time using MODBUS TCP, enabling it to be integrated easily into larger control systems or connected to a data recorder

PC Configuration

The CMF160 can be fully configured using ABB's ConfigPilot software. Available free of charge, ConfigPilot enables off-line creation and editing of configuration files. Configurations are transferred to and from the indicator via its standard IrDA port and a USB IrDA adapter.

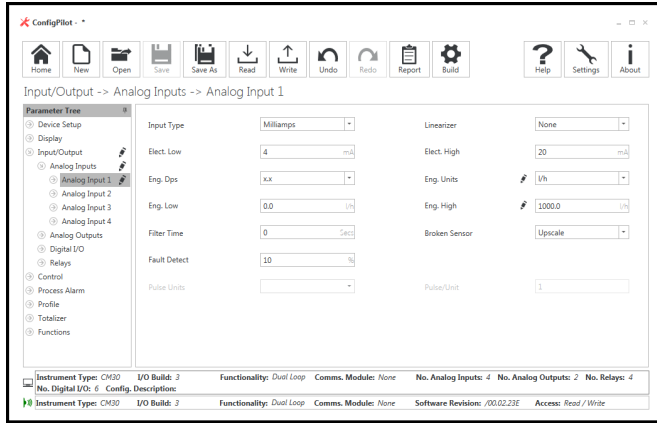

Figure 8 Analog input configuration

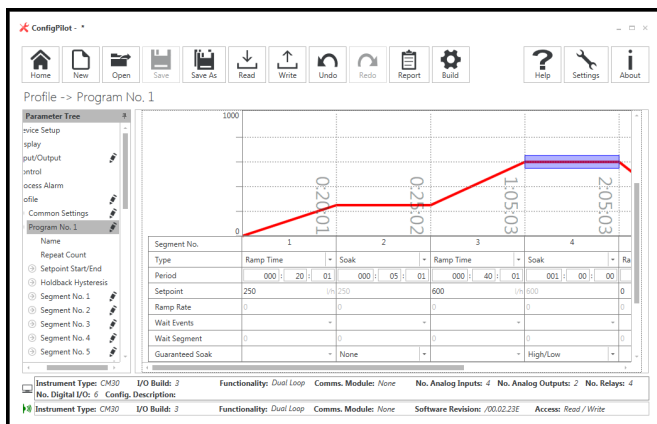

Figure 9 Profile configuration

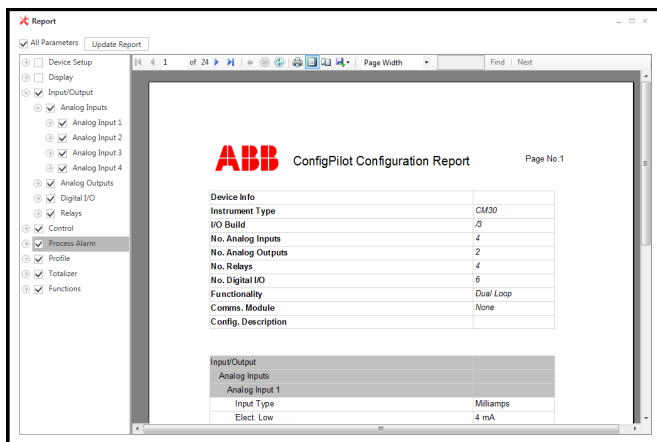

Figure 10 Configuration report generation

Bank control

Bank control enables improved control of multi-element output devices such as banks of heaters, pumps and fans. Aimed at minimizing wear caused by over-use of one specific 'duty' device, bank control enables wear to be levelled by sharing duty and assist handling between every device in the bank.

Ideal for pump control applications in the water and waste water industry. Up to six pumps can be controlled each with independent on and off trip points (see Figure 11). The CMF160's universal process input, complete with transmitter power supply, makes it suitable for connection to many kinds of standard level transmitters.

Bank control provides users the choice of either 'Rotate' or 'First In, First Out (FIFO)' wear-leveiling schedules. Rotate cycles which pump is the first to switch on during a pumping event. FIFO ensures that the last pump to switch of is the last pump to be called again. Figure 12 details Rotate and FIFO cycling for a 3-pump system.

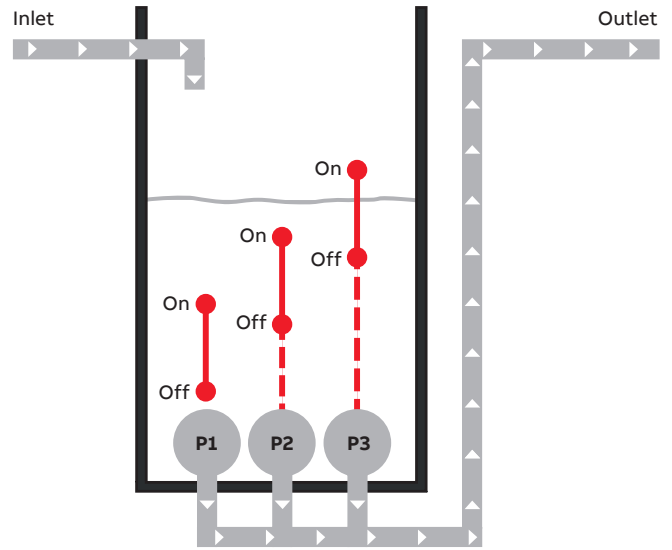

Figure 11 Independent on and off trip points

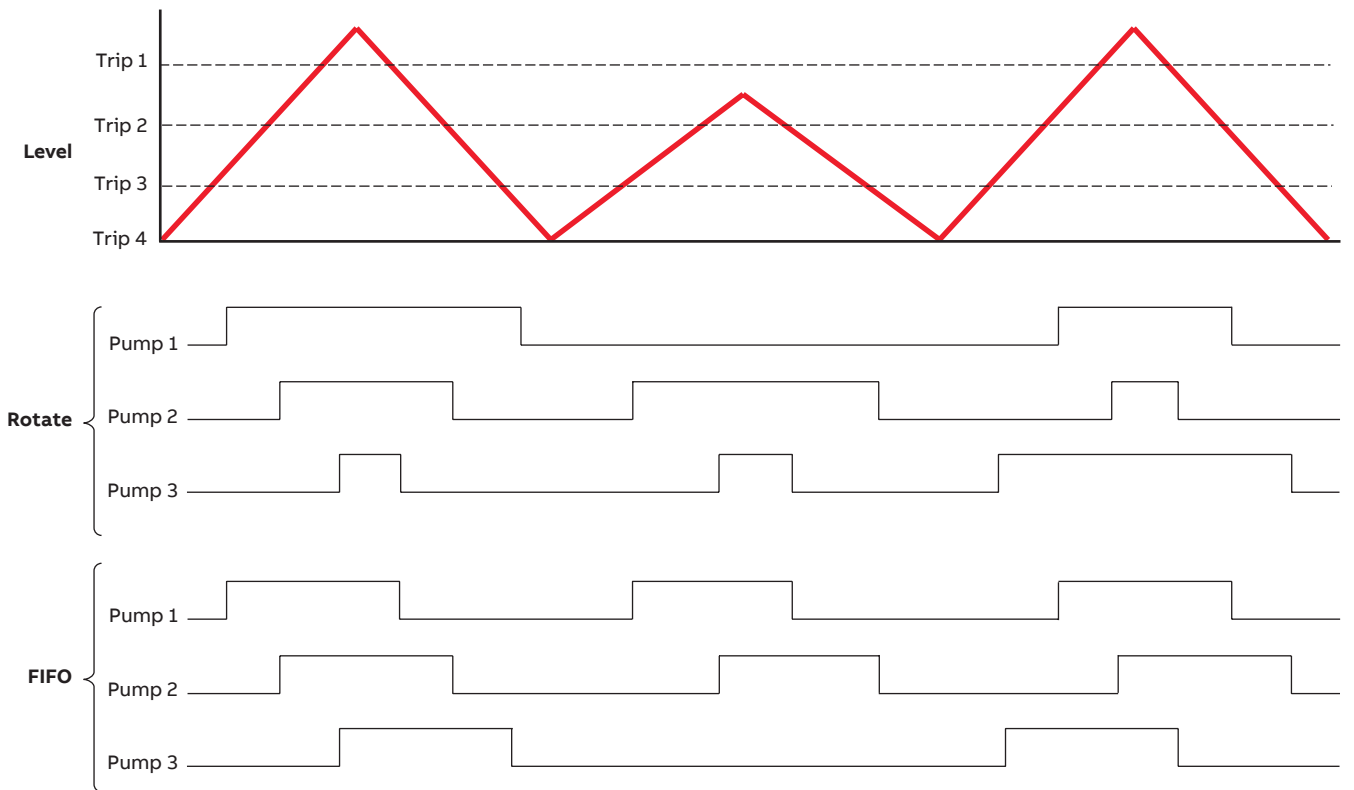

Figure 12 Rotate and FIFO cycling for a 3-pump system

Application templates

To minimize commissioning time, the CMF160 features up to 8 pre-configured templates. Simply selecting the required template configures the CMF160's function blocks and display automatically. Customization of the pre-configured templates is also possible, providing the flexibility to create versatile solutions.

Single PV indication

This template provides indication of a single process value.

In this example, the CMF160 is indicating the temperature of a heat treatment furnace:

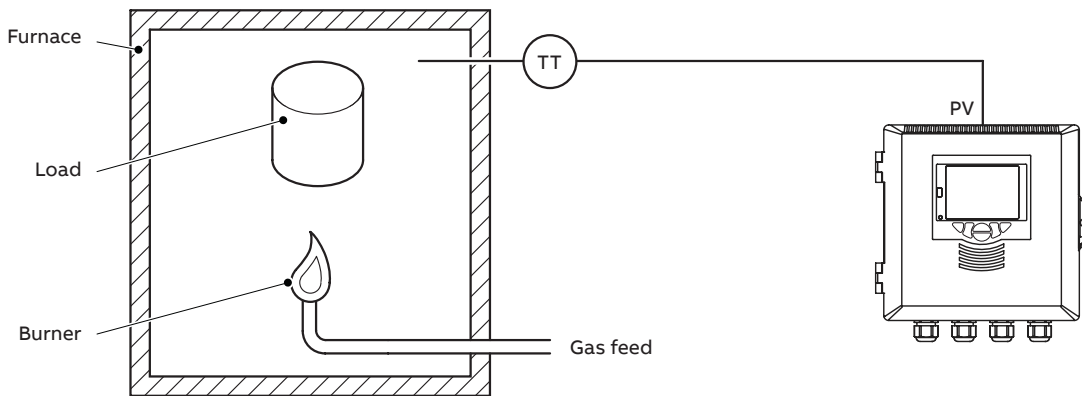

Single PV with totalization

This template adds totalization to the single PV indication template.

In this example, the CMF160 is monitoring a pipeline to provide indication of instantaneous flow rate and totalization and could be connected to the flowmeter via an analog (for example 4 to 20 mA) or frequency signal:

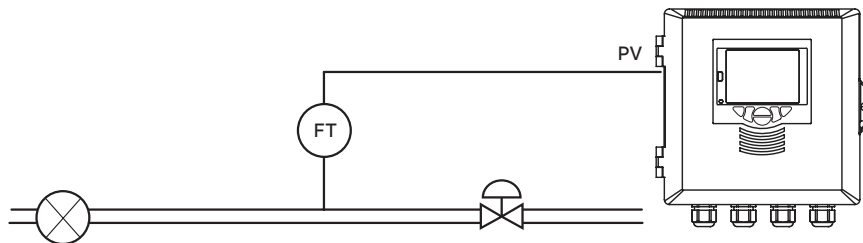

Single totalizer

This template provides totalization only.

In this example, the CMF160 is counting the number of products passing a specific point on a production line:

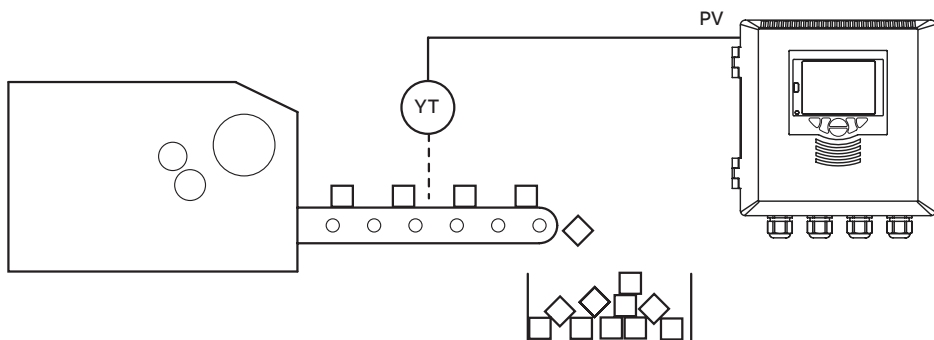

...Application templates

Single level with volume

The single level with volume template adds level specific functions to the single PV indication template. The volume contained within a vessel can be calculated and indicated and products of varying specific gravity accounted for.

In this example, the CMF160 is monitoring the level of product in a storage tank and calculating the associated volume:

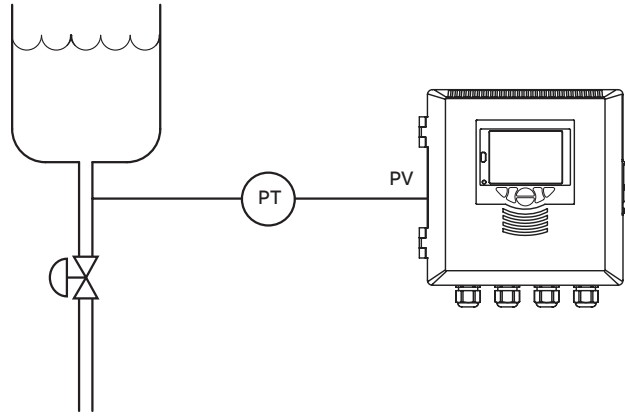

Dual indication

This template provides indication of 2 process values. Variations of this template are available providing dual PV with totalization, dual totalization or dual level indication.

In this example, a single CMF160 is providing indication of both the flow through, and temperature of, a heat exchanger:

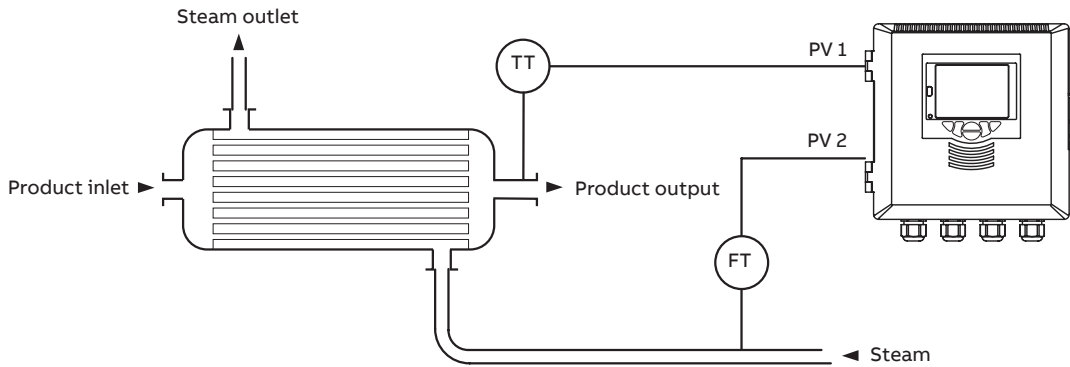

Specification

Operation

Display

Color, ¼ VGA TFT, liquid crystal display (LCD)
with built-in backlight

Language

English, German, French, Italian and Spanish

Operator keypad

6 tactile membrane keys

Security

Password protection

Basic / Advanced – user-assigned password protection
(not set at factory)

Standard functions

Base templates

Single PV indication
Single PV indication + totalizer
Counter
Single PV indication + level

Dual templates

Dual PV indication
Dual PV indication + totalizer
Dual counter
Dual PV indication + level

Process alarms

Number

8

Types

High / Low process
High / Low latch

Source

Fully configurable
(for example – PV, Analog input, Math block inbuilt)

Hysteresis

Level and time

Alarm enable

Enable / Disable individual alarms via a digital signal

Acknowledgment

Via front panel keys or digital signals

Real-time alarms*

Number

2

Programmable

Time
Day
Duration

Math blocks*

Number

8

Operators

+, -, x, /
Average, Maximum, Minimum
High / Low / Median select
Square root
Multiplexer

Delay timers*

Number

2

Programmable

Delay
Duration

Logic equations*

Number

8

Elements

15 per equation

Operators

OR, AND, NOR, NAND, NOT, EXOR

Custom linearizer*

Number

2

Elements

20 breakpoints

Bank control*

Number of outputs

6

Wear leveling

Rotate or FIFO

Totalizer

Number **

Up to 2

Type

Analog, digital, frequency or pulse

Statistical calculations

Average, maximum, minimum (for analog signals)

Update rate

125 ms

* Functionality level 'Standard' and above only

** Single totalizer available with base functionality, dual totalizers available with dual functionality

...Specification

Analog inputs

Universal process inputs

Number

- 1 standard
- 1 optional

Type

- Voltage
- Current
- Resistance (ohms)
- 3-Wire RTD
- 4-Wire RTD
- Thermocouple
- Digital volt-free
- Digital 24 V
- Frequency

Non-universal process inputs

Number

- 1 standard
- 1 optional

Type

- Voltage
- Current
- Thermocouple *
- Digital volt-free
- Digital 24 V

Thermocouple types

B, E, J, K, L, N, R, S, T

Resistance thermometer

Pt100

Other linearizations

\sqrt{x} , $x^{3/2}$, $x^{5/2}$, custom linearization

Digital filter

Programmable 0 to 60 s

Display range

-9999 to 99999

Update rate

125 ms

Common mode noise rejection

> 120 dB at 50 / 60 Hz with 300 Ω imbalance resistance

Normal (series) mode noise rejection

> 60 dB at 50 / 60 Hz

CJC rejection ratio

Stability

0.05 °C/°C change in ambient temperature

Temperature stability

0.02 %/°C or 2 μ V/°C (1 μ V/°F)

Long term (input) drift

< 0.1 % of reading or 10 μ V annually

Input impedance

> 10 M Ω (mV input)

10 Ω (mA input)

* Only if universal process input is configured as 'Thermocouple'

Inputs

Thermocouple	Maximum range °C (°F)	Accuracy (% of reading)
B	-18 to 1800 (0 to 3270)	0.1 % or ±2 °C (3.6 °F) (above 200 °C [392 °F]) *
E	-100 to 900 (-140 to 1650)	0.1 % or ±0.5 °C (0.9 °F)
J	-100 to 900 (-140 to 1650)	0.1 % or ±0.5 °C (0.9 °F)
K	-100 to 1300 (-140 to 2350)	0.1 % or ±0.5 °C (0.9 °F)
L	-100 to 900 (-140 to 1650)	0.1 % or ±1.5 °C (2.7 °F)
N	-200 to 1300 (-325 to 2350)	0.1 % or ±0.5 °C (0.9 °F)
R	-18 to 1700 (0 to 3000)	0.1 % or ±1 °C (1.8 °F) (above 300 °C [540 °F]) *
S	-18 to 1700 (0 to 3000)	0.1 % or ±1 °C (1.8 °F) (above 200 °C [392 °F]) *
T	-250 to 300 (-400 to 550)	0.1 % or ±0.5 °C (0.9 °F) (above -150 °C [-238 °F]) *

* Accuracy is not guaranteed at temperatures below this value

RTD	Maximum range °C (°F)	Accuracy (% of reading)
Pt100	-200 to 600 (-325 to 1100)	0.1 % or ±0.5 °C (0.9 °F)

Linear inputs	Standard analog input	Accuracy (% of reading)
Millivolts	0 to 150 mV	0.1 % or ±20 µV
Milliamperes	0 to 45 mA	0.2 % or ±10 µA
Volts	0 to 25 V	0.2 % or ±20 mV
Resistance (low)	0 to 550 Ω	0.2 % or ±1 Ω
Resistance (high)	0 to 10 kΩ	0.1 % or ±5 Ω
Sample Interval		125 ms per sample

Digital inputs

Type	Volt-free or 24 V	
Minimum pulse duration	Single input configured – 250 ms Both inputs configured as analog or digital – 500 ms	
Volt-free	Contact open > 10 MΩ / contact closed < 100 KΩ	

Frequency input*

Frequency range	0 to 6000 Hz
1-signal	15 to 30 V
0-signal	-3 to 5 V

*For use with devices with open collector outputs

Outputs

Retransmission outputs

Number

4 (2 standard, 2 optional)

Isolation

Galvanically isolated from the rest of the circuitry,
500 V for 1 minute

Analog range

0 to 20 mA programmable

Load

750 Ω max.

Accuracy

0.25 % of output or ±10 µA

Relays

Number

6 (4 standard, 2 optional)

Type

Standard with changeover contacts

Contact ratings

2 A, 240 V

Update rate

125 ms

Digital I/O

Number

6 (standard)

Type

User-programmable as input or output
Minimum input pulse duration – 125 ms

Input

Volt-free:
contact open >10 MΩ
contact closed <100 KΩ

24 V DC:
1-signal 15 to 30 V
0-signal -3 to 5 V

TTL:
Low: 0 to 0.8 V
High: 2 to 5 V
Conforms to IEC 61131-2

Output

Open collector output
30 V, 100 mA max. switched
Conforms to IEC 61131-2

Update rate

125 ms

2-Wire transmitter power supply

Number

1 optional

Voltage

24 V DC

Drive

2 loops, 45 mA max.

...Specification

Communications

Note. Only one communications option can be fitted per indicator.

IrDA configuration port (standard)

Baud rate

Up to 115 kBaud

Distance

Up to 1 m (3 ft)

Functions

Firmware upgrade

Configuration upload / download

Ethernet (optional)

Type

10BaseT

Connector

RJ 45

Protocols

TCP/IP

HTTP

MODBUS TCP (Slave)

Web server

Built-in – enables remote monitoring using standard web browsers

Email

- Can be configured to be sent on the occurrence of a specified event
- Up to 3 recipients
- Up to 4 trigger sources with configurable tag

MODBUS RTU (optional)

Baud rate

Up to 115 kBaud

Isolation

Galvanically isolated from the rest of the circuitry, 500 V DC for 1 minute

EMC

Emissions & immunity

Meets requirements of IEC 61326 for an industrial environment

Environmental

Operating temperature range

0 to 55 °C (32 to 131 °F)

Operating humidity range

5 to 95 % RH (non-condensing)

Storage temperature range

-20 to 70 °C (-4 to 158 °F)

Enclosure sealing

IP 66 & NEMA 4X

Altitude

2000 m (6562 ft) max. above sea level

Safety

General safety

- Overvoltage Class III on mains, Class II on inputs and outputs
- Pollution degree 2, insulation class 1

Approvals and certifications

EN 61010-1

cULus (optional):

UL file number E236966

UL Class 1, Division 2 (optional):

- Groups A, B, C and D
- Temperature rating T4
- In accordance with ANSI / ISA 12.12.01-2013 and CAN / CSA C22.2 No. 213-M1987
- UL file number E474414

Isolation

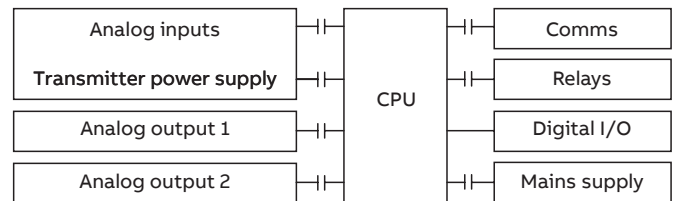

Key

—||— = Isolation

Electrical

Supply ranges

100 to 240 V AC $\pm 10\%$ (90 V min. to 264 V max.)

50 / 60 Hz

Power consumption

25 W max.

Power interruption protection

No effect for interrupts of up to 60 ms

Physical

Size

194 x 214 x 98 mm (7.6 x 8.4 x 3.8 in.)

Weight

1.5 kg (3.3 lb) approx. (unpacked)

Panel cutout

186 x 186 mm (7.3 x 7.3 in.)

Case material

Glass-filled polycarbonate

Electrical connections

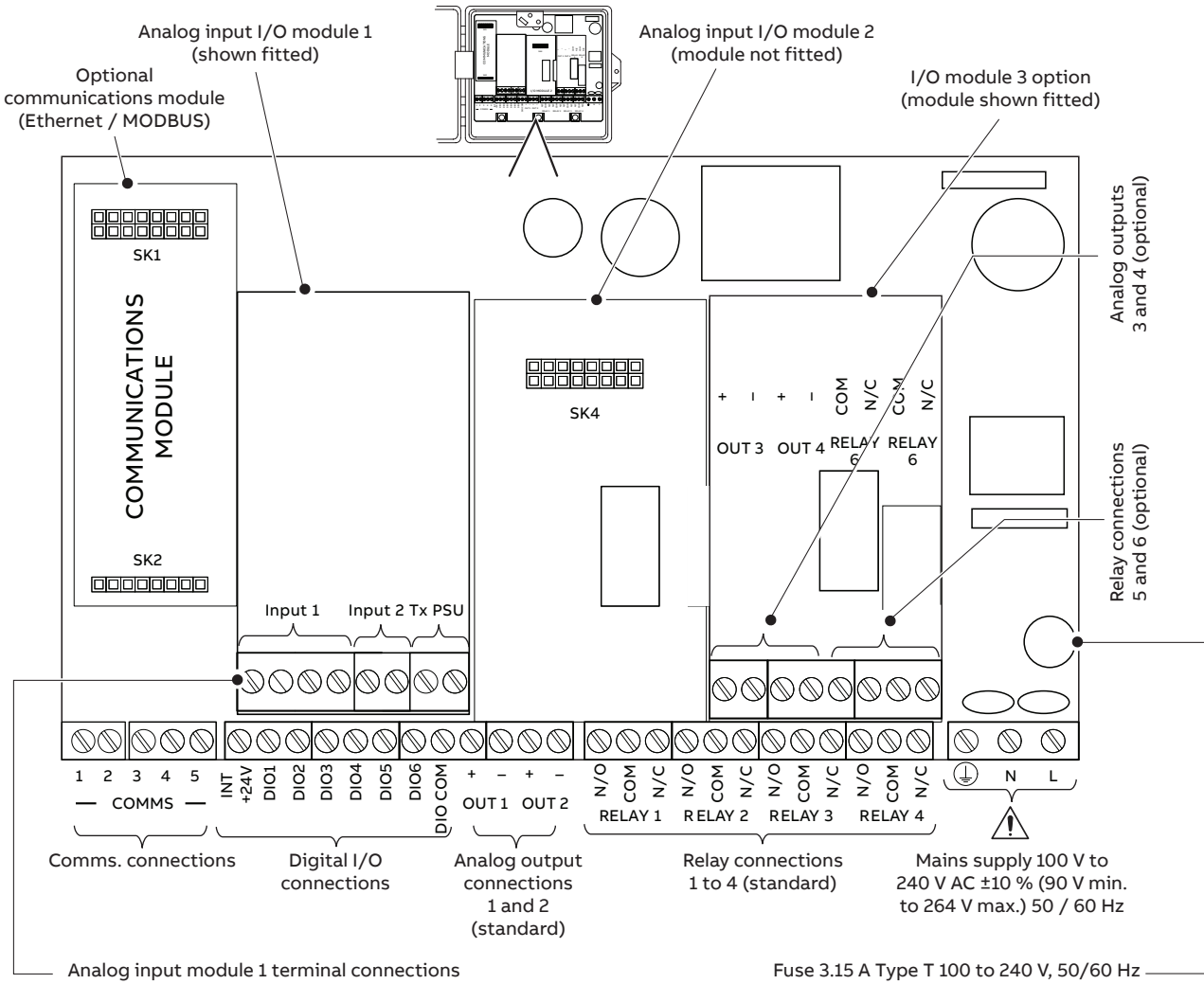

Overall dimensions

Dimensions in mm (in.)

Transmitter

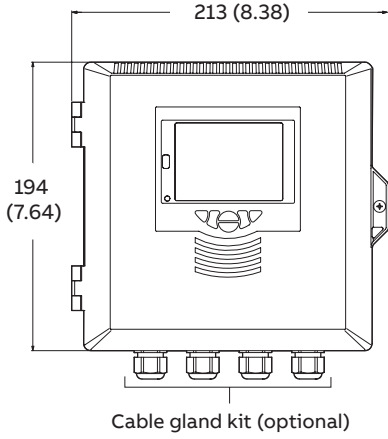

Wall mount option

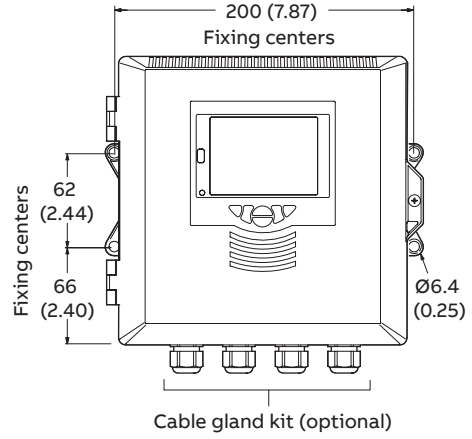

Pipe mount option

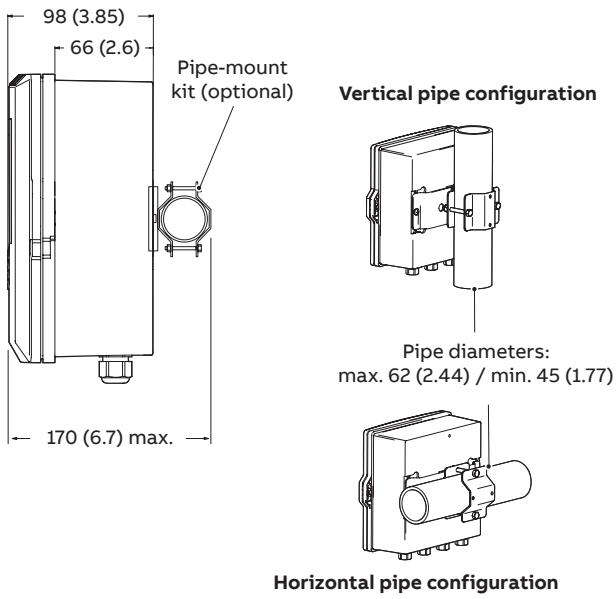

Panel mounting

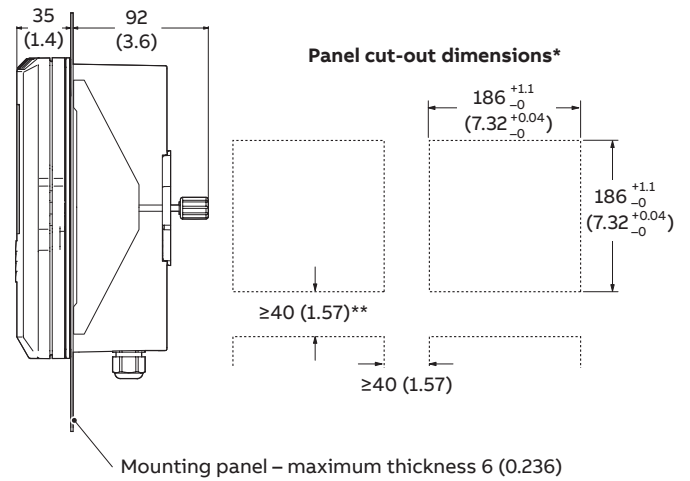

* To DIN43700

** ≥150 mm (6 in.) if (optional) cable glands fitted

Ordering information

ControlMaster CMF160 universal process indicator, fieldmount	CMF160	AN	AN	AN	A	N	A	N	A	N	A	N	A	N	A	N	A	OPT
Option module 1 Dual analog input	A2																	
Option module 2 Not fitted Dual analog input			Y0 A2															
Option module 3 Not fitted Analog and relay output				Y0 H2														
Template / Functionality level Base Standard Dual point indication					A B C													
Communications Not fitted Ethernet RS 485 MODBUS						0 1 2												
Approval Standard CE cULus approval cULus Class 1 Div. 2							A B C											
Power supply 90 to 264 V AC								1										
Branding ABB Standard Unbranded front panel and start-up screen									A B									
HMI Language English German Spanish French Italian										5 1 3 4 2								
Expansion 1 None													Y					
Configuration Standard (factory default) Custom (configuration details required) Engineered configuration (requirement details required)														1 2 3				
Mounting hardware Wall Wall and panel															A B			
Cable glands None (blanking plugs) Standard cable gland pack Ethernet cable gland pack																0 1 2		
Expansion 2 None																		Y
Calibration certificate Certificate of calibration **																		C1
Printed instruction manual English German Spanish French Italian																		M5 M1 M3 M4 M2

Product ordering code example:
CMF160 A2 Y0 H2 B 0 A 1 A 5 Y 1 A 1 Y-C1-M5

** When a calibration certificate is ordered it is performed according to the specified configuration type:
CUS/ENG – Inputs and outputs calibrated according to the customer supplied configuration details and ranges.
STD – Inputs and outputs calibrated according to the instrument factory standard configuration and ranges.

Standard accessories

Included with each controller:

- Commissioning instructions

Optional accessories

- ConfigPilot PC configuration kit CM30/0715
- Pipe mounting kit CM40/0700 (page 16)
- Weathershield kit CM40/0702 (see below)
- After-sales engineered configuration service ENG/CON

Weathershield kit (pipe- and wall-mount installations)

Dimensions in mm (in.)

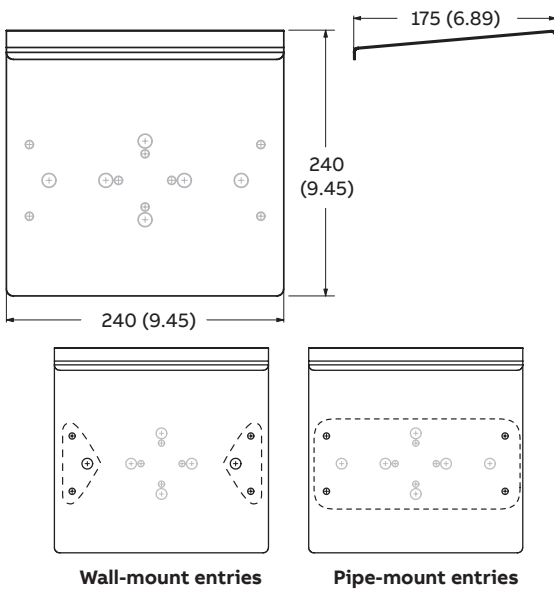

Acknowledgements

MODBUS is a registered trademark of the Modbus-IDA organization.

Sales



Service



Software





Soluciones en Instrumentación,
Automatización y Control Industrial

www.seita.com.co

ABB Measurement & Analytics

For your local ABB contact, visit:
www.abb.com/contacts

For more product information, visit:
www.abb.com/measurement

We reserve the right to make technical changes or modify the contents of this document without prior notice. With regard to purchase orders, the agreed particulars shall prevail. ABB does not accept any responsibility whatsoever for potential errors or possible lack of information in this document.

We reserve all rights in this document and in the subject matter and illustrations contained therein. Any reproduction, disclosure to third parties or utilization of its contents – in whole or in parts – is forbidden without prior written consent of ABB.

© Copyright 2021 ABB
All rights reserved.